

Table of Contents

| | |
|--|-------------------|
| Sales Policies, Warranty, Service, Mission & Green Statement | i & ii |
| How to read our catalog, How to order, How to price | iii & iv |
| Increments & Cut Downs, Care & Maintenance, Features, Assembly Comparisons | v, vi, vii & viii |

2100 Series

Square Edge - Laminate

| | |
|--|-----------------|
| Double Pedestal/Single Pedestal/Fan Desk, Credenzas, Desks w/Return, Reception Unit | 1 |
| Hutches, Work Tables, Lateral Files, Vertical Files, Occasional Tables | 2 |
| Bookcases, Storage Cabinets, Vertical Storage Cabinets, Groups, Computer Corner w/Return | 3, 4 & 5 |
| Components, Conference Tables, Cylinder Base, Conference Cabinet | 6, 7, 8, 9 & 10 |
| Lectern, Wall Overhead, Stand Alone & Built In Pedestals | 11 |
| Options, Colors, Grommets, Hardware | 12,13 & 14 |

2100

3100 Series

Square Edge - Laminate

| | |
|--|-----------------|
| Double Pedestal/Single Pedestal/Fan Desk, Credenzas, Desks with Return | 15 |
| Work Tables, Lateral Files, Vertical Files | 16 |
| Groups & Computer Corners w/Return | 17 & 18 |
| Components, Stand Alone Pedestals | 19, 20, 21 & 22 |
| Options, Colors, Grommets, Hardware | 23, 24, & 25 |

3100

2200 Series

Radius End - Laminate

| | |
|--|--------------|
| Double/Single Pedestal, Credenzas, Desks w/Return & Computer Corner w/Return | 27 |
| Computer U-Shape Desks, Hutches, Work Tables, Lateral Files & Vertical Files | 28 |
| Components, Bookcases, Occasional Tables, Stand Alone & Built In Pedestals | 29, 30, & 31 |
| Options, Colors, Grommets, Hardware | 32, 33, & 34 |

2200

2300 Series

4 Way Edge Detail - Laminate

| | |
|---|---------------------|
| Double Pedestal/Single Pedestal/Fan Desk, Credenzas, Desks w/Return, Reception Unit | 35 |
| Hutches, Work Tables, Lateral Files, Vertical Files, Occasional Tables | 36 |
| Bookcases, Storage Cabinets, Vertical Storage Cabinets | 37 |
| Computer U-Shape Desks, U-Shape Desks, Bullet U-Shape Desks, Computer Corner w/Return | 38 |
| Components, Conference Tables, Conference Cabinet, Lectern | 39, 40, 41, 42 & 43 |
| Cylinder Base, Wall Overhead, Stand Alone & Built In Pedestals | 44 |
| Options, Colors, Grommets, Hardware | 45, 46, & 47 |

2300

3300 Series

4 Way Edge Detail - Laminate

| | |
|--|-----------------|
| Double Pedestal/Single Pedestal/Fan Desk, Credenzas, Desks w/Return | 49 |
| Work Tables, Lateral Files, Vertical Files | 50 |
| Computer U-Shape Desks, U-Shape Desks, Bullet U-Shape Desks & Computer Corner w/Return | 51 |
| Components, Stand Alone Pedestals | 52, 53, 54 & 55 |
| Options, Colors, Grommets, Hardware | 56, 57, & 58 |

3300

Table of Contents

| | | | | |
|---|--|---|---------------------|--------------------|
| Congress Series | | Traditional Detailing - Laminate | | Congress |
| Double/Single Pedestal, Credenzas, Desks w/Return, U-Shape Workstations | | | 59 | |
| Computer U-Shape Desks, Reception Units, Huches, Work Tables, Lateral Files, Vertical Files | | | 60 | |
| Storage Cabinets, Occasional Tables, Components | | | 61 & 62 | |
| Bookcases, Conference Tables, Conference Cabinet | | | 63 & 64 | |
| Options, Colors, Grommets, Hardware | | | 65, 66, & 67 | |
| Office Series | | 8 Way Radius Detail - Veneer | | Office |
| Double Pedestal/Single Pedestal/Fan Desk, Credenzas, Desks w/Return, Reception Unit | | | 69 | |
| Hutches, Work Tables, Lateral Files, Vertical Files, Occasional Tables | | | 70 | |
| Bookcases, Storage Cabinets, Vertical Storage Cabinets | | | 71 | |
| Computer U-Shape Desks, U-Shape Desks, Bullet U-Shape Desks, Computer Corner w/Return | | | 72 | |
| Components, Conference Tables, Conference Cabinet, Lectern | | | 73, 74, 75, 76 & 77 | |
| Cylinder Base, Wall Overhead, Stand Alone & Built In Pedestals | | | 78 | |
| Options, Colors, Grommets, Hardware | | | 79, 80, & 81 | |
| 8200 Series | | 4 & 2 Way Edge Detail - Veneer | | 8200 |
| Double Pedestal/Single Pedestal/Fan Desk, Credenzas, Desks w/Return, Reception Unit | | | 83 | |
| Hutches, Work Tables, Lateral Files, Vertical Files, Occasional Tables | | | 84 | |
| Bookcases, Storage Cabinets, Vertical Storage Cabinets | | | 85 | |
| Computer U-Shape Desks, U-Shape Desks, Bullet U-Shape Desks, Computer Corner w/Return | | | 86 | |
| Components, Conference Tables, Conference Cabinet, Lectern | | | 87, 88, 89, 90 & 91 | |
| Cylinder Base, Wall Overhead, Stand Alone & Built In Pedestals | | | 92 | |
| Options, Colors, Grommets, Hardware | | | 93, 94, & 95 | |
| 9200 Series | | 4 & 2 Way Edge Detail - Veneer | | 9200 |
| Double Pedestal/Single Pedestal/Fan Desk, Credenzas, Desks w/Return | | | 97 | |
| Work Tables, Lateral Files, Vertical Files | | | 98 | |
| Computer U-Shape Desks, U-Shape Desks, Bullet U-Shape Desks & Computer Corner w/Return | | | 99 | |
| Components, Stand Alone Pedestals | | | 100, 101, 102 & 103 | |
| Options, Colors, Grommets, Hardware | | | 104, 105, & 106 | |
| Traditional Series | | | | Traditional |
| Double/Single Pedestal, Credenzas, Desks w/Return, U-Shape Workstations | | | 107 | |
| Computer U-Shape Desks, Reception Units, Huches, Work Tables, Lateral Files, Vertical Files | | | 108 | |
| Storage Cabinets, Occasional Tables, Components | | | 109 & 110 | |
| Bookcases, Conference Tables, Conference Cabinet | | | 111 & 112 | |
| Options, Colors, Grommets, Hardware | | | 113, 114, & 115 | |
| Individual Hardware | | | | |
| Individual Uninstalled Hardware | | | 117 & 118 | |

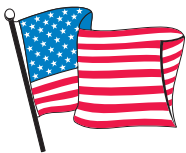

**Made in the
United States
of America**

James Edward Furniture

Sales Policies

Dealer Sales and Discount Policies

Contact your James Edward Furniture (JEF) sales representative or our Customer Service department for information about dealer sales and our discount policies.

Pricing and Specifications

Prices and Specifications of the products in this catalog are subject to change without notice. JEF reserves the right to make changes or improvements in its products without incurring any obligation to similarly alter products to match previously produced products. All orders are subject to JE's pricing at the time of order placement.

Ordering Information

All orders are subject to approval and acceptance by JEF. Possession of the catalog and/or price list shall not constitute an offer to sell.

The dealer assumes all responsibility to supply complete and correct information for the products on their order. Any omissions will delay the timely processing of the order. JEF does not rush orders that are delayed due to incorrect or missing information. A Fax copy of the order must follow orders placed by phone before the order will be processed. No exceptions. Orders may be faxed directly to Customer Service department. Please check your Order Acknowledgments to verify the accuracy of your order. JEF will build and ship according to the Order Acknowledgement. All Cancellations Or Changes Must Be Approved In Writing (Via Fax) And Are Subject To JEF's Approval. Orders May Not Be Changed Or Canceled Once Production Has Begun.

Return Policy

JEF will only accept returns authorized in advance and accompanied by a copy of our Return Goods Authorization form. If shipped product is Refused for any reason the dealer may be charged up to the full amount of the shipped product plus all freight costs if JEF is found to be not at fault. JEF reserves the right to restock particular products at its sole discretion. Restocking charges will apply to these products and charges will be quoted on a case-by-case basis. Please call Customer Service for assistance.

Terms and Conditions of Sale

Terms are subject to credit approval. A late charge of 1 1/2% per month will be added to all past-due accounts. The late charge is not intended to create a credit arrangement.

Packing, Will Call and Freight

All JEF products are packaged standard with stretch wrap and corner guards. Additional packing may be required or requested for shipping at an additional charge. See catalog or call for information and pricing.

Will Call Hours: Monday-Friday 8:00 a.m. to 4:00 p.m. (Phoenix time). After notification of completion of your order, please call the Customer Service department to schedule a pick-up time. Calling ahead will ensure that your order is ready when you arrive.

Due to production requirements and space limitations, Will Call merchandise must be picked up within 5 working days after completion date. Product left after five days will be required to be picked up before other orders. JEF will notify dealer by phone when this status occurs. Orders completed before due dates of post dated purchase orders are the only exception. JEF reserves the right to ship or store merchandise left after

10 working days at customer expense.

All freight shipped merchandise is shipped F.O.B. Phoenix, AZ. Shipments will be made "best way" unless other arrangements are made or specified on your sales order.

Damaged or Lost Shipments

JEF is not responsible for damage or loss in shipment by common carriers. Products shipped are delivered to the carrier in good condition. When the transfer is made, JEF's liability ceases. Title to shipped goods passes to the dealer upon JEF's delivery of the goods to the carrier. Dealers should protect themselves by assuring that the common carrier has noted the extent of any damage or shortage on the Bill of Lading before the dealer signs for receipt of product.

Freight damage and/or loss claims with common carriers are the responsibility of the dealer. Dealer should follow all requirements set forth by the carrier to make a claim. Upon request, JEF Customer Service will provide necessary documentation where possible to assist your claim. Damage or loss claims should be filed within the time requirements set forth by the carrier. To file a successful freight claim the damage or loss should be noted as an exception on the delivery receipt and an inspection report must be obtained.

Limited Warranty

JEF warrants to the original purchaser that:

JEF casegoods products will be free from defects in material and workmanship (excepting finish) under single shift usage for ten (10) years from the original date of purchase.

JEF warrants the finish of its products under normal usage for one (1) year from the original date of purchase.

This warranty is made solely to the original purchaser of record and shall be effective from the date of purchase as shown on the purchaser's receipt. This warranty is void for any damages to the JEF product due to misuse, abuse, neglect, accident, improper installation, failure to comply with instructions furnished by JEF or any repair or alteration performed by anyone other than JEF or an authorized JEF dealer. Damage caused by common carrier during shipment is not included in this warranty. During the warranty period, as set forth above, if any JEF products sold, which are subject to this warranty, prove to be defective in material and/or workmanship under normal use, the purchaser must contact an authorized JEF dealer or JEF in writing or by telephone to arrange for inspection of such JEF product by an authorized representative. The JEF representative, after inspection, and at their sole discretion, will issue a return authorization for such JEF product. No JEF product will be accepted for return without prior authorization from JEF or an authorized JEF representative. JEF shall, at its option, either (1) provide parts necessary to repair such JEF product free of charge, or (2) issue a mutually acceptable credit for such product. THE FOREGOING LIMITED WARRANTY IS JEF'S ONLY WARRANTY, WRITTEN OR VERBAL ON ITS PRODUCTS. NO OTHER STATEMENT, AGREEMENT, OR REPRESENTATION BY ANY PERSON SHALL BIND JE. EXCEPT AS SET FORTH ABOVE, THERE IS NO WARRANTY, REPRESENTATION OR CONDITION OF ANY KIND, EXPRESS OR IMPLIED (INCLUDING, BUT NOT LIMITED TO, ANY WARRANTY OF NON-INFRINGEMENT, MERCHANTABILITY OR FITNESS FOR A PARTICULAR USE OR PURPOSE), AND NONE WILL BE IMPLIED BY LAW. JEF WILL NOT BE HELD LIABLE TO DEALER OR PURCHASER OR ANY OTHER PARTY FOR ANY PUNITIVE, SPECIAL, CONSEQUENTIAL OR INCIDENTAL DAMAGES OR FOR LOST PROFITS OR GOODWILL RESULTING FROM ANY BREACH OF WARRANTY, NEGLIGENCE OR ANY OTHER CAUSE OR THEORY.

James Edward Furniture Service & Mission Statement

James Edward Furniture(JEF) does not view Dealers only as customers, but as partners, in delivering the best valued furniture to both our customer, the end user. Without a satisfied customer in the office environment neither our Dealers or JEF succeeds. With this in mind we ask our dealers to participate with James Edward Furniture in delivering the best service and products at the best price. With producing and shipping any product, at times there may be problems, how the problem is handled is what sets a well know name apart from the rest. All problems will be handled in a manner effective toward both, the customer and in the keeping of value of our product, by JEF and our Dealers.

Our Mission

At James Edward Furniture, our mission is to provide our customers with quality products, a high level of service and timely information. We strive to maintain close relationships with our customers and suppliers, which enables us to provide among the highest level of value and on-time service in the industry.

Ultimately, our goal is not to be the largest furniture provider, but to be your largest furniture provider.

Green Statement

JEF is committed to designing and manufacturing products in a manner that protects our work and world environments. We demonstrate our commitment by producing products that are environmentally friendly throughout its life cycle. JEF monitors each stage of a product's life to improve its impact on the environment. These stages include materials, manufacturing, delivery, use and disposal.

Materials Sourcing

JEF strives to use materials that are processed in an environmentally responsible manner. This includes the quality of materials for long life or materials consisting of a high level of recycled material. We encourage our suppliers to use recycled materials where feasible in their production process.

Manufacturing

JEF uses manufacturing processes that are environmentally friendly. Materials used contain no Ozone Depleting Substances (ODSs) (Chlorofluorocarbons (CFCs) or Hydrochlorofluorocarbons (HCFCs)). Our systems are in full compliance with EPA requirements concerning Clean Air and Clean Water. We recycle scrap wood, paper, corrugated waste, wood dust as well as use electrical management devices and high efficiency motors.

Delivery

JEF shipment system reduces fuel usage by consolidated shipments and route control.

Use and Disposal

JEF designs and manufactures products with a long life cycle to reduce disposals. JEF products carry a ten-year warranty (with a few exceptions) and are designed to last beyond that timeframe. A quality product with a long life cycle means fewer products sent to waste sites which are a major source of environmental problems.

How To Read Our Catalog

Our Model Numbers:

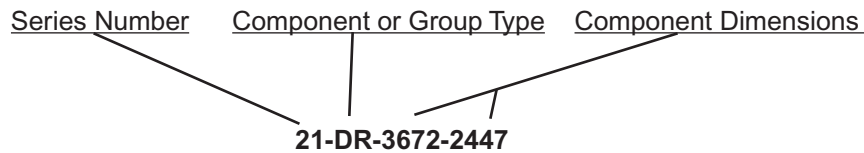

This example is a Series **21** Desk with **Return** with two components. Component 1 (in this case the Desk) is **36** inches wide by **72** inches long, while Component 2 is a **24** inch wide by **47** inch long return.

A comprehensive listing of Component/Group type abbreviations is shown below.

A model number which indicates a group will have the individual components listed immediately after it. Those components will be preceded by a (•).

| Model Number | Depth | Width | Height | List | Weight | Cube |
|--------------------------|-------|-------|--------|---------|--------|------|
| 23-CR-3666-2042 | 77 | 66 | 29 | \$1,800 | 290 | 62 |
| • 23-CCCsp-3666 w/1 lock | 36 | 66 | 29 | \$1,224 | 205 | 45 |
| • 23-Ret-2042 | 20 | 42 | 29 | \$576 | 85 | 17 |
| 23-SP-2448 w/1 lock | 24 | 48 | 29 | \$858 | 170 | 23 |
| 23-SP-3048 w/1 lock | 30 | 48 | 29 | \$886 | 180 | 28 |

Component/GroupType Abbreviations:

| | | | | | |
|-------|--|----------|--|-------|--------------------------------|
| ABr | Angled bridge | CDsp | Computer desk single ped (Compatible with 24" returns & bridges) | LF | Lateral file |
| ARet | Angled return | CP | Computer P-shaped top | LFS | Lateral file storage |
| B | Bullet top | CR | Computer corner w/ return | LT | Lecturn |
| BC | Bookcase | CPU | Computer pullout Unit | MOD | Modesty panel |
| BCU | Bullet U shape w/ computer corner credenza (CCCsp) | Csp | Credenza single ped | NCU | U shape w/ regular credenza(C) |
| BNCU | Bullet U shape w/reg. credenza (C) | DP | Double ped desk | OH | Wall hanging overhead |
| Boat | Boat shaped table | DR | Desk with return | Op | Option |
| BR | Bridge | DRUM MOD | Drum base and full modesty panel available where noted | OT | Occasional table |
| C | Credenza | Dsp | Desk single ped | P | P shaped top |
| CB | Computer bullet top | FCF | File closed file | PED | Pedestal w/drawers |
| CBC | Corner bookcase | FDP | Fan desk double ped | PPO | Printer pullout |
| CBCH | Corner bookcase hutch | FDR | Fan desk w/ return | PS | Personal storage |
| CCCsp | Computer corner credenza w/single ped | FDsp | Fan desk single ped | Race | Racetrack table |
| CCDsp | Computer corner desk w/single ped | FOF | File open file | Rec | Rectangular table |
| CD | Computer desk | GROM | Grommet | Recep | Reception |
| CH | Corner hutch | Group | Indicates a common grouping (only in 2100 Series) | Ret | Return |
| CFC | Conference cabinet | H | Hutch | RND | Round table |
| CU | U shape w/ computer corner credenza (CCCsp) | KBT | Keyboard | SP | Single pedestal |
| | | LAM | Laminate | SQR | Square table |
| | | | | SC | Storage cabinet |
| | | | | VF | Vertical file |
| | | | | VS | Vertical Storage |
| | | | | WD | Wood |
| | | | | WT | Work table |

How to Order an Item

Please help us help you by ordering an item using our model numbers and providing all pertinent information. Any missing information causes delays in processing your which extends your due date. We do not rush orders that are missing information.

Required Information - This information may vary based on series/item ordered.

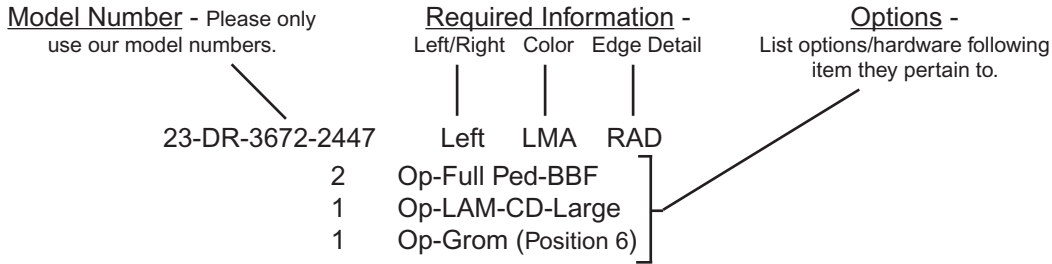

How To Price Your Furniture

This example will help you price options, colors, cut downs, and special finishes.

| Model Number | Depth | Width | Height | List | Weight | Cube |
|--------------------------|-------|-------|--------|---------|--------|------|
| 21-CR-3666-2042 | 78 | 66 | 29 | \$1,210 | 290 | 65 |
| • 21-CCCsp-3666 | 36 | 66 | 29 | \$780 | 205 | 47 |
| • 21-Ret-2042 | 20 | 42 | 29 | \$430 | 85 | 18 |
| 82-DP-3672 w/2 lock | 36 | 72 | 29 | \$1676 | 145 | 24 |

The items above will be modified according to the option page located on the last page of each pertaining series.

| | |
|---|--|
| <p>\$1,210</p> <p>Full ped with lock Box Box File configuration on desk \$212</p> <p>Full ped with lock File File configuration on return \$212</p> <hr/> <p>Sub Total: \$1,634</p> | <p style="text-align: center;">Step 1</p> <p>Total the item, cut down and increment charges, and all options from the options page .</p> |
| <p>Special Formica Laminate Top only 20%</p> <p>Slate Gray (LSG) Base only N/C</p> <hr/> <p>Pre-Hardware Total \$1960.80</p> <p>Standard keyboard tray \$118.00</p> <hr/> <p>Total: \$2,078.80</p> | <p style="text-align: center;">Step 2</p> <p>Add your mixed color or high pressure top percentages to the above sub-total for a pre-hardware total.</p> <p style="text-align: center;">Step 3</p> <p>Add all hardware from the hardware and grommet pages to get the total list price.</p> |

| | |
|--|--|
| <p>82-DP-3672 \$1,676</p> <p>(2) Full ped with lock Box box file configuration \$492</p> <hr/> <p>Sub Total: \$2,168</p> | <p style="text-align: center;">Step 1</p> <p>Total the item, cut down and increment charges, and all options from the options page .</p> |
| <p>Special Formica Laminate Top only 20%</p> <p>Cherry Veneer Upgrade 10%</p> <p>Custom stain match (min. \$350) 15%</p> <hr/> <p>Pre-Hardware Total \$3168.40</p> <p>Standard keyboard tray \$118.00</p> <hr/> <p>Total \$3286.40</p> | <p style="text-align: center;">Step 2</p> <p>Add your upgrade color, high pressure top, high gloss percentages.</p> <p style="text-align: center;">Step 3</p> <p>If custom stain match applies determine whether the \$298 minimum or 15% custom stain charge applies: 1,828 x .15 = 274.20</p> <p style="text-align: center;">Step 4</p> <p>Add all hardware from the hardware and grommet pages to get the total list price.</p> |

All dollar figure modifications to construction must be added to base list price before special finish option percentage up charges are applied.

Increments and Cut Downs

Increments:

Adding Increments are used only to increase the width of an item. The cost should be multiplied by the number of incremental increases desired. Limitations apply. Please call if there is any question on unusually long items.

Cut Downs:

Cut downs are used only to decrease the width of an item. Please specify the size to the nearest inch when ordering cut downs. There are some limitations to certain items that can not be cut down or are limited in how much they can be cut down due to interference with certain pedestal choices, particularly on computer corner credenzas and computer desks. Please call if there is any item in question concerning cut downs.

Care & Maintenance

Laminate:

Care and Maintenance

To clean the surface, use a damp cloth or sponge and a mild soap or detergent. Difficult stains such as coffee or tea can be removed using a mild household cleaner and baking soda; mixing to achieve a paste consistency. Use a stiff nylon bristle brush, scrubbing (approx. 15-20 strokes) the affected area. Do not scrub so as to mar (damage, scratch) the surface finish.

Stubborn stains that resist any of the above cleaning methods may require the use of undiluted household bleach or nail polish remover. Use a cotton ball saturated with bleach or nail polish remover (acetone); gently rub the stain for up to two minutes. Rinse thoroughly with warm water and wipe dry using a soft cloth. This step may be repeated if the stain appears to be going away and the color of the laminate has not been affected.

Veneer:

Care and Maintenance

We recommend dusting frequently with a lint free cloth. (ALWAYS RUB WITH THE GRAIN) If wet cleaning is necessary use a wax base product. Blot spills immediately to prevent discoloration. Avoid direct sunlight to prevent fading. Avoid direct contact with heating and air conditioning vents to prevent moisture changes. Always use a coaster for both hot and cold beverages. Be aware that certain felts and plastics used can bleed through the finish.

Laminate Furniture Features

Standard on all laminate Products

9 Ply Birch drawers with UV coating are standard on all items. Ultraviolet coatings have incredible durability and superior coating protection. Ultraviolet coatings contain no solvents and pollutants when cured. Ultraviolet curing is 100% environmentally safe. Drawers are constructed with steel pins and glued with rabbit joints.

Drawer slides are all full extension with ball bearing suspension, this provides for very smooth action, Constructed with high-grade steels that is corrosion and scratch resistant, along with Danish tooling that improves tolerances for accuracy provides for better wear and extended life. Tested and passed all BIFMA and WIC tests.

Laminate Furniture with hardwood edges is finished with our multi-step Catalyzed Conversion Varnish Finishing process. This brings out the natural beauty of the wood, resists alcohol, nail polish remover and many other chemicals.

Laminate desks use Thermo-Fused melamine laminated on 1 1/8" & 3/4" top quality ANSI Grade 1M# 45-pound particleboard. The undersides of our laminate work surfaces are protected by a moisture-resistant "backer sheet finished to the same specs as the surface." 45 lbs. Particle board has much more density than typical commercial grade particle board providing the maximum holding strength for glue lines, screws & fasteners. This means that your furniture can provide the maximum durability during moving and the daily work environment without impairing construction.

Thermo-Fused Laminate is composed of multiple layers of paper saturated with resin, and finished with a printed surface. (In recent years, the quality of printing has become so good that it is occasionally hard to distinguish laminate from real wood.) These layers are pressed together under high heat and pressure, creating a solid, solvent and abrasion-resistant material.

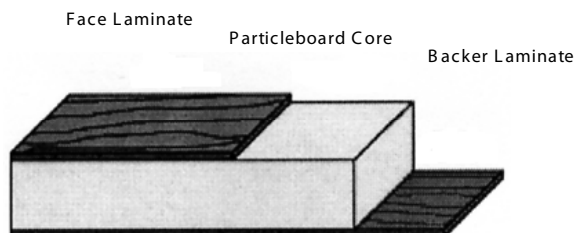

FACTS REGARDING LAMINATE:

- Laminate is one of the most durable material available for work surfaces and requires little maintenance.
- It is highly resistant to dents and scratches.
- Laminate has a more consistent color and grain than veneer, making it suitable for settings where multiple desks will be placed side by side.
- Laminate is easy to clean and is excellent for high activity areas.
- Laminate has a look that approaches veneer, at a fraction of the price.

All Laminate Series

- Adjustable 1" leveling glides on all items. (except bookcases)
- 100 lbs. Capacity drawers on box drawers & file Drawers, 150 lbs. on lateral file drawers.
- European hinges are used on all doors.
- All file drawers, file letter and legal files.
- One piece vertical grain modesty.
- Superior fastening construction of Pedestal to Modesty resists top sagging.
- Extra deep T-nuts for levelers resists side panel blowout.
- All Locks keyed alike.

2100 Series Laminate

- Shapes and sizes to reach any configuration possible.
- Budget Priced.
- 1 mm Impact Resistant PVC. Edge.
- Standard box file configuration.

3100 Series Laminate

- Transitional Style.
- Selected Shapes and sizes to reach popular configurations.
- Budget Priced.
- 1 mm Impact Resistant PVC. Edge.
- Standard box box file configuration.

2200 Series Laminate

- 1 1/8" Solid Hardwood molding at each end of work surface with catalyzed conversion varnish.
- 1 mm Impact Resistant PVC. Edge.
- Standard box file configuration.

2300 Series Laminate

- 1 1/8" Solid Hardwood molding around every work surface with catalyzed conversion varnish.
- Molding assembled with tongue & groove construction.
- 1 mm Impact Resistant PVC. Edge.
- Standard box file configuration.

3300 Series Laminate

- Transitional Style.
- 1 1/8" Solid Hardwood molding around every work surface with catalyzed conversion varnish.
- Molding assembled with tongue & groove construction.
- Standard box box file configuration.

Congress Series Laminate

- Traditional Style.
- 1 1/8" Solid Hardwood molding around every work surface with catalyzed conversion varnish.
- Dictation Pullouts.
- Standard box box file configuration.
- High sheen tops.

Veneer Furniture Features

Standard on all Veneer Products

9 Ply Birch drawers with UV coating are standard on all items. Ultraviolet coatings have incredible durability and superior coating protection. Ultraviolet coatings contain no solvents and pollutants when cured. Ultraviolet curing is 100% environmentally safe. Drawers are constructed with steel pins and glued with rabbit joints.

Drawer slides are all full extension with ball bearing suspension, this provides for very smooth action, Constructed with high-grade steels that is corrosion and scratch resistant, along with Danish tooling that improves tolerances for accuracy provides for better wear and extended life. Tested and passed all BIFMA and WIC tests.

Veneer communicates the ultimate in richness and status. Virtually everyone appreciates the deep luster and changing play of light that is inherent in real wood furniture. If you are shopping for "real wood" office furniture, you're probably looking at veneer in almost every situation.

Our veneer is laid over a particleboard substrate. Particleboard is a combination of small wood fiber chips, fused with durable resins. The ANSI Grade 1M# 45-pound board we use is the best available. Because of this durable substrate, veneer furniture resists warping and the possibility of moisture damage better than solid hardwood. This is a typical veneer furniture panel:

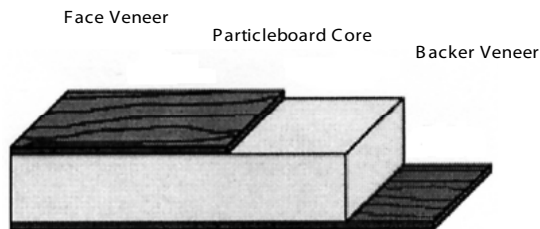

TYPES OF WOOD:

- Wood is classified as either hardwood or softwood. Softwoods are primarily derived from evergreen trees such as pine, spruce, redwood and cedar.
- Hardwoods generally come from broad leaf trees that lose their leaves in the fall & winter. Examples are Oak, Ash, Walnut, Cherry and Mahogany. Our veneer casegoods are manufactured from cherry, oak and Maple veneers. Our mahogany color is actually maple or cherry with a deep red stain. The Maple veneer has a smoother finish than real mahogany. The Cherry veneer has a more attractive grain and a smoother finish than real mahogany. These species are abundantly available in North America.

APPLICATION STYLES:

- Veneer is generally a 1/32" thick slice, taken from

- the log generally in two different manners.
- Rotary Cut is a cut in which the log is turned and the veneer is sliced off as the log is spun, like when you peel an apple.
- Plane sliced is when the veneer is sliced off in strips like a cheese grader.
- Each gives the grain of the wood a much different look.
- Veneer is also categorized in different layouts as the veneers are matched for the layout process; these are the most common.
- Bookmatching places sheets of veneer face-to-face to form symmetrical patterns.
- Slipmatching places veneer segments side-by-side instead of face-to-face. This creates a more linear appearance.
- To improve your furniture's appearance we use most of these applications in the veneer process. Depending on the color of your furniture, the natural graining in the wood and the different looks of the cutting process are all considered to provide the best possible appearance of your furniture.
- Our multi-step Catalyzed Conversion Varnish finishing process brings out the natural beauty of the wood, and resists alcohol, nail polish remover, and many other chemicals.

All Veneer Series

- Adjustable 1" leveling glides on all items. (except bookcases)
- European hinges on all doors.
- Self closing doors on all hutches.
- All file drawers file letter and legal files.
- One piece vertical grain modesty.
- Superior fastening construction of Pedestal to Modesty prevents top sagging.
- Extra deep T-nuts for levelers resists side panel blowout.
- Catalyzed Conversion Varnish finish. (resists alcohol and nail polish remover)
- All Locks keyed alike.

Office Series Veneer

- High-grade hand selected veneers.
- Solid Hardwood molding on bottom of all side panels helps prevent damage in a commercial environment.
- Standard box file configuration.

8200 Series Veneer

- High-grade hand selected veneers.
- Solid Hardwood molding on bottom of all side panels helps prevent damage in a commercial environment.
- Standard box file configuration.

9200 Series Veneer

- High-grade hand selected veneers.
- Transitional Style.
- Standard box box file configuration.

Traditional Series Veneer

- High-grade hand selected veneers.
- Solid Hardwood molding.
- Dictation Pullouts.
- Standard box box file configuration.

James Edward Furniture Assembly Construction

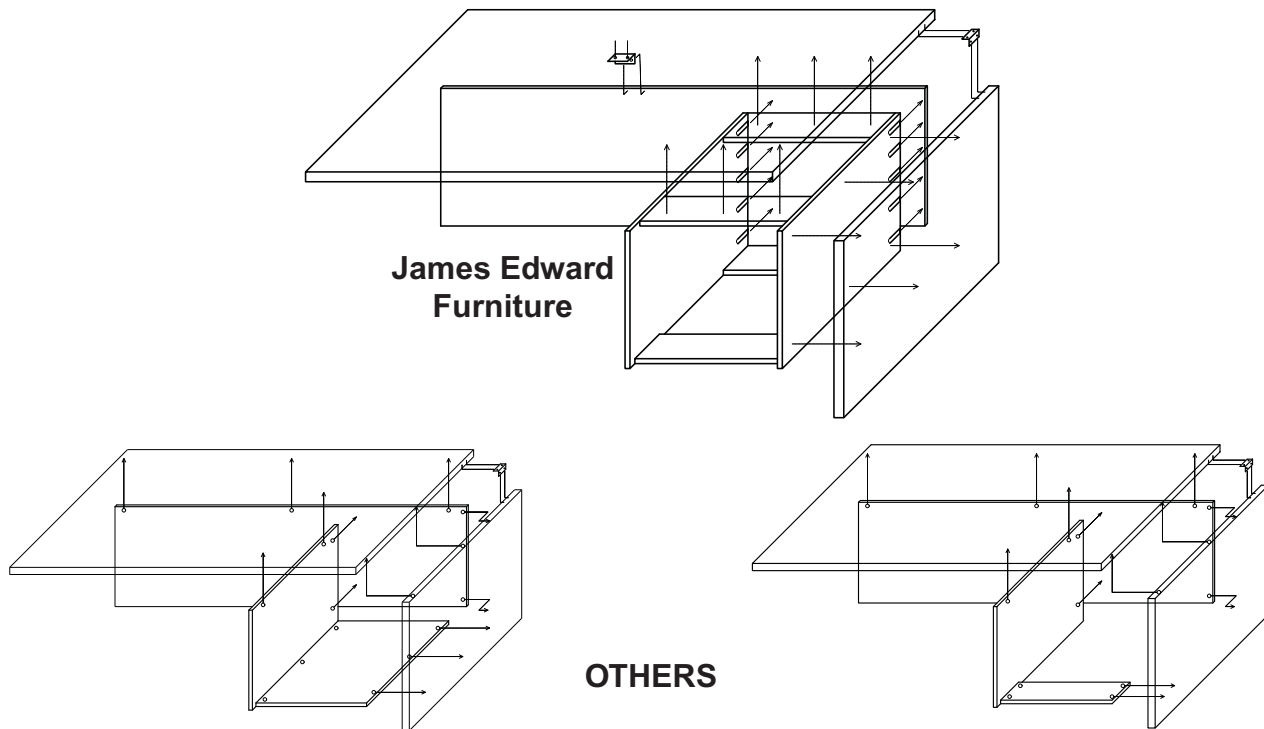

JEF

- Pedestals are attached to modesty panel with 10 screws. Resists pedestal sagging and collapse.
- Side panels are attached to pedestal with 5 - 8 extra long screws and bracketed to top, depending on size. Resists side panel failure while moving furniture.
- Cam locks are used only on Hutches and Bookcases, not heavy items like Desks, Credenzas and Reception units which need stronger assembly methods. 18 Cam locks are used on hutches.
- 9 ply UV coated birch plywood drawers. Resists moisture and spills and has superior strength.
- 4 sided inner drawer. Independent drawer fronts allow easy replacement of damaged fronts caused by chairs.
- Synthetic wood glues used on pedestal and moulding assembly. Adds superior strength and rigidity.
- 100 % Solid hardwood moulding, with tongue and grooved method used on most mouldings. Prevents edge detachment and allows for refinishing of damaged mouldings.

OTHERS

- As many as half the screws attaching pedestals or cam locks without a complete independent pedestal. Pedestals can break free causing settling, sagging or collapse.
- Side panels attached with fewer screws or only cam locked to modesty and braces with few cam locks. Side panels tear off in moving or sliding.
- Cam locks used on all sizes of furniture. Greatly reduced strength on heavy items causing structure failure in moving or requires disassembly before moving to prevent damage.
- Vinyl wrapped or printed Particleboard or MDF drawers. Poor resistance to moisture and spills and reduced strength due to poor gluing properties of these materials.
- 3 sided inner drawer. Drawer fronts can not be replaced without replacing the whole drawer or pedestal.
- Wrapped edge details instead of solid hardwood. Main panels are easily damaged and not always repairable.

A superior assembly method simply means, your furniture lasts longer. From daily abuse, to moving cross country, JEF furniture last longer and endures more abuses than many other manufacturers. This also means JEF furniture can be as little as half the cost of other manufacturers in the long run (Including Imports).

2100 Series

Functional, Contemporary Laminate Designs Offering Clean Lines with Modular Convenience.

Laminate

Square Edge

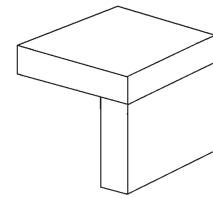

2100

Standard Features:

- Full Suspension on all Drawers.
- Box/File Pedestals.
- Touch Latch Doors on Credenzas.
- File Drawers Supplied with Rods for Hanging Legal and Letter Files.
- Matching Vertical Grain Drawer Fronts.
- 1/2" 9 Ply UV Coated Birch Drawer Material
- One Piece Vertical Grain Modesty Panels
- 20" Depth on Credenzas, Returns, Lateral Files, and Bridges.
- Adjustable Leveling Glides (Except Bookcases).
- Thermofused Laminate on all Tops and Sides.
- Locks Keyed Alike.

Desks - Double Pedestal/Single Pedestal/ Fan Top Desk (DP/SP/FDP)

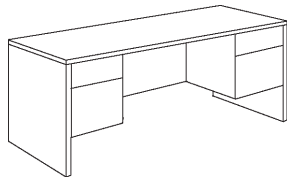

| Model Number | Depth | Width | Height | List | Weight | Cube |
|--|-------|-------|--------|---------|--------|------|
| 21-DP-3060 | 30 | 60 | 29 | \$708 | 265 | 36 |
| 21-DP-3066 | 30 | 66 | 29 | \$756 | 275 | 40 |
| 21-DP-3672 | 36 | 72 | 29 | \$860 | 305 | 51 |
| 21-SP-2448 | 24 | 48 | 29 | \$476 | 135 | 24 |
| 21-SP-3048 | 30 | 48 | 29 | \$594 | 145 | 29 |
| \$176 List to add 6" increments (\$122 List cut downs) | | | | | | |
| 21-FDP-3066 | 36 | 66 | 29 | \$1,094 | 295 | 51 |
| 21-FDP-3672 | 42 | 72 | 29 | \$1,204 | 325 | 59 |

Credenzas (C-Open/C-Cab)

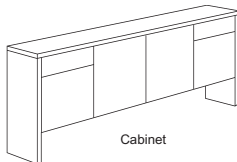

| | | | | | | |
|--|----|----|----|-------|-----|----|
| \$210 List to add 6" increments (\$176 List cut downs) | | | | | | |
| 21-C-2060-Cab | 20 | 60 | 29 | \$708 | 223 | 25 |
| 21-C-2060-Open | 20 | 60 | 29 | \$708 | 205 | 25 |
| 21-C-2066-Cab | 20 | 66 | 29 | \$756 | 229 | 27 |
| 21-C-2066-Open | 20 | 66 | 29 | \$756 | 211 | 27 |
| 21-C-2072-Cab | 20 | 72 | 29 | \$860 | 235 | 30 |
| 21-C-2072-Open | 20 | 72 | 29 | \$860 | 217 | 30 |
| 24" Credenza depth add \$176 List | | | | | | |
| \$176 List to add 6" increments (\$122 List cut downs) | | | | | | |

Desks and Fan Top Desks, with Returns (DR/FDR)

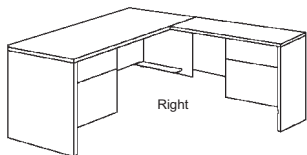

| | | | | | | |
|--|----|----|----|---------|-----|----|
| 21-DR-3060-2042 | 72 | 60 | 29 | \$1,054 | 280 | 54 |
| • 21-Dsp-3060 | 30 | 60 | 29 | \$624 | 195 | 36 |
| • 21-Ret-2042 | 20 | 42 | 29 | \$430 | 85 | 18 |
| 21-DR-3066-2447 | 77 | 66 | 29 | \$1,228 | 335 | 63 |
| • 21-Dsp-3066 | 30 | 66 | 29 | \$684 | 215 | 40 |
| • 21-Ret-2447 | 24 | 47 | 29 | \$544 | 120 | 23 |
| 21-DR-3672-2047 | 83 | 72 | 29 | \$1,152 | 320 | 71 |
| • 21-Dsp-3672 | 36 | 72 | 29 | \$712 | 225 | 51 |
| • 21-Ret-2047 | 20 | 47 | 29 | \$440 | 95 | 20 |
| 21-DR-3672-2447 | 83 | 72 | 29 | \$1,256 | 345 | 74 |
| • 21-Dsp-3672 | 36 | 72 | 29 | \$712 | 225 | 51 |
| • 21-Ret-2447 | 24 | 47 | 29 | \$544 | 120 | 23 |
| \$176 List to add 6" increments (\$122 List cut downs) | | | | | | |
| 21-FDR-3672-2447 | 89 | 72 | 29 | \$1,570 | 375 | 82 |
| • 21-FDsp-3672 | 42 | 72 | 29 | \$1,026 | 255 | 59 |
| • 21-Ret-2447 | 24 | 47 | 29 | \$544 | 120 | 23 |

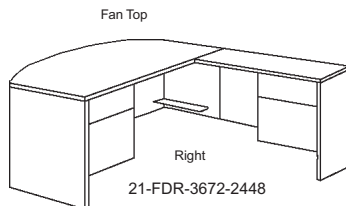

Reception Unit (Recep)

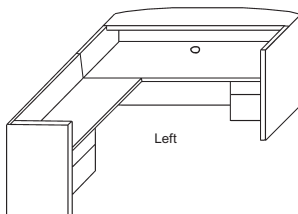

| | | | | | | |
|--|----|----|----|---------|-----|----|
| See components for special sizes | | | | | | |
| 21-Recep-3072-2447 | 77 | 72 | 43 | \$2,930 | 530 | 96 |
| • 21-Recep-3072 | 30 | 72 | 43 | \$2,052 | 380 | 62 |
| • 21-Recep-Ret-2447 | 24 | 47 | 43 | \$878 | 150 | 34 |
| \$298 List to add 6" increments (\$210 List cut downs) | | | | | | |

Sizes are nominal.

2100 Series

Functional, Contemporary Laminate Designs Offering Clean Lines with Modular Convenience.

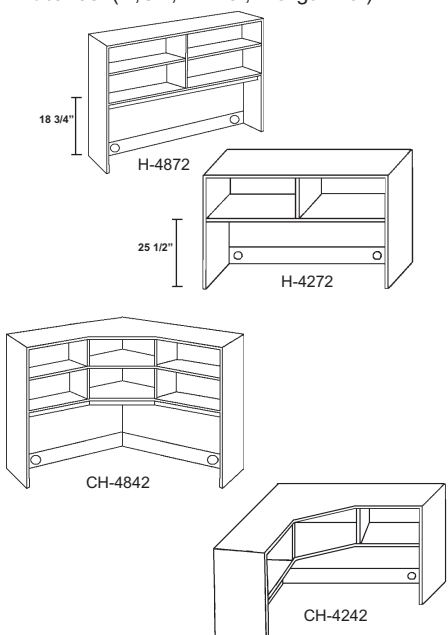
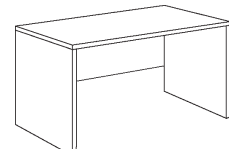
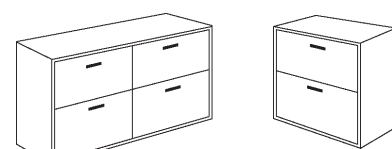
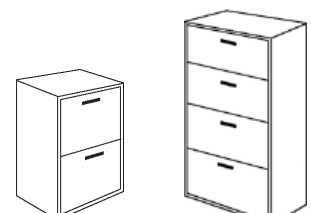
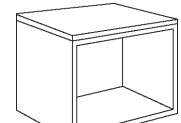
| | Model Number | Depth | Width | Height | List | Weight | Cube |
|--|--|-------|-------|--------|---------|--------|------|
| Hutches (H,CH,H-Filler,H-Organizer)  | 21-H-4845 | 14 | 45 | 48 | \$684 | 140 | 24 |
| | 21-H-4857 | 14 | 57 | 48 | \$684 | 150 | 28 |
| | 21-H-4863 | 14 | 63 | 48 | \$782 | 155 | 30 |
| | 21-H-4869 | 14 | 69 | 48 | \$782 | 160 | 33 |
| | 21-H-4245 | 14 | 45 | 43 | \$586 | 120 | 20 |
| | 21-H-4257 | 14 | 57 | 43 | \$586 | 130 | 25 |
| | 21-H-4263 | 14 | 63 | 43 | \$630 | 135 | 27 |
| | 21-H-4269 | 14 | 69 | 43 | \$630 | 140 | 30 |
| | 21-CH-4836 | 36 | 36 | 48 | \$976 | 150 | 42 |
| | 21-CH-4842 | 42 | 42 | 48 | \$1,030 | 160 | 56 |
| | 21-CH-4236 | 36 | 36 | 43 | \$778 | 130 | 37 |
| | 21-CH-4242 | 42 | 42 | 43 | \$820 | 140 | 50 |
| | 21-H-48-Filler (Fills space between hutches) | 1 | 4 | 48 | \$126 | 3 | 1 |
| | 21-H-42-Filler | 1 | 4 | 42 | \$126 | 3 | 1 |
| OP-H-Organizer | 10 | 12 | 12 | \$168 | 4 | 1 | |
| \$210 List cut downs (not available on corner hutch) Doors not standard See options for door types | | | | | | | |
| Work Tables (WT)  | 21-WT-2036 | 20 | 36 | 29 | \$296 | 65 | 15 |
| | 21-WT-2042 | 20 | 42 | 29 | \$296 | 85 | 18 |
| | 21-WT-2048 | 20 | 48 | 29 | \$318 | 95 | 20 |
| | 21-WT-2060 | 20 | 60 | 29 | \$418 | 100 | 25 |
| | 21-WT-2072 | 20 | 72 | 29 | \$470 | 115 | 30 |
| | 21-WT-2448 | 24 | 48 | 29 | \$318 | 110 | 24 |
| | 21-WT-3048 | 30 | 48 | 29 | \$364 | 130 | 29 |
| | 21-WT-3060 | 30 | 60 | 29 | \$450 | 140 | 36 |
| | 21-WT-3672 | 36 | 72 | 29 | \$542 | 160 | 51 |
| | \$176 List to add 6" increments (\$122 List cut downs) | | | | | | |
| Lateral Files (LF)  | 21-LF-2038-2D w/handles (B1) | 20 | 38 | 29 | \$588 | 170 | 16 |
| | 21-LF-2072-4D w/handles (B1) | 20 | 72 | 29 | \$1,078 | 330 | 30 |
| | Locks Standard | | | | | | |
| Vertical Files (VF)  | 21-VF-2423-2D w/handles (B1) | 24 | 23 | 29 | \$502 | 120 | 12 |
| | 21-VLF-2038-4D w/handles (B1) | 20 | 38 | 54 | \$1,262 | 330 | 30 |
| | Locks Standard | | | | | | |
| Occasional Tables (OT)  | 21-OT-2020 | 20 | 20 | 20 | \$276 | 40 | 7 |
| | 21-OT-2048 | 20 | 48 | 20 | \$388 | 65 | 15 |
| \$176 List to add 6" increments (\$122 List cut downs) | | | | | | | |

Sizes are nominal.

2100 Series

Functional, Contemporary Laminate Designs Offering Clean Lines with Modular Convenience.

2100

Bookcases (BC)

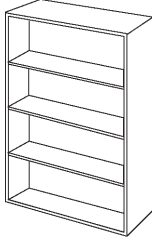

| Model Number | Depth | Width | Height | List | Weight | Cube |
|---|-------|-------|--------|-------|--------|------|
| 21-BC-2936-1 | 12 | 36 | 29 | \$274 | 70 | 10 |
| 21-BC-4834-2L For 2-D Lateral No Bottom | 14 | 34 | 48 | \$446 | 75 | 15 |
| 21-BC-4836-2 | 12 | 36 | 48 | \$372 | 85 | 16 |
| 21-BC-6036-3 | 12 | 36 | 60 | \$450 | 100 | 20 |
| 21-BC-7236-4 | 12 | 36 | 72 | \$528 | 115 | 23 |
| 21-BC-8436-5 | 12 | 36 | 84 | \$644 | 140 | 27 |
| 21-BC-3612-BKSLF Bookcase Shelf | 12 | 36 | 1.1 | \$62 | 6 | 1 |
| 21-BC-L-Cab 29" Lower Cabinet (72" & 84" only) | | | | \$296 | 15 | |
| \$210 List cut downs | | | | | | |

Corner Bookcases / Corner Bookcase Hutch (CBC / CBCH)

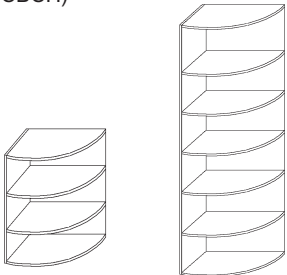

| | | | | | | |
|---------------|----|----|----|-------|-----|----|
| 21-CBC-2029-1 | 20 | 20 | 29 | \$442 | 70 | 9 |
| 21-CBC-2072-4 | 20 | 20 | 72 | \$756 | 115 | 21 |
| 21-CBCH-1448 | 14 | 14 | 48 | \$618 | 70 | 8 |
| 21-CBCH-1442 | 14 | 14 | 42 | \$618 | 65 | 7 |

Storage Cabinets (SC)

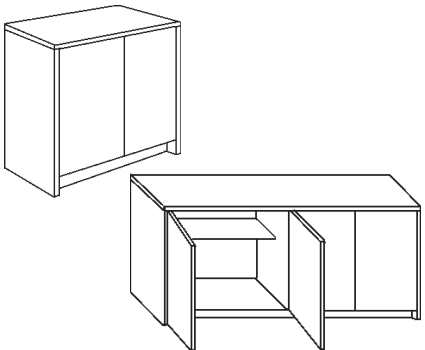

| | | | | | | |
|------------|----|----|----|---------|-----|----|
| 21-SC-2019 | 20 | 19 | 29 | \$472 | 110 | 8 |
| 21-SC-2032 | 20 | 32 | 29 | \$588 | 120 | 13 |
| 21-SC-2038 | 20 | 38 | 29 | \$588 | 130 | 15 |
| 21-SC-2060 | 20 | 60 | 29 | \$1,000 | 155 | 25 |
| 21-SC-2072 | 20 | 72 | 29 | \$1,152 | 165 | 30 |

Storage - Vertical / Personal / Lateral File (VS/PS/LFS)

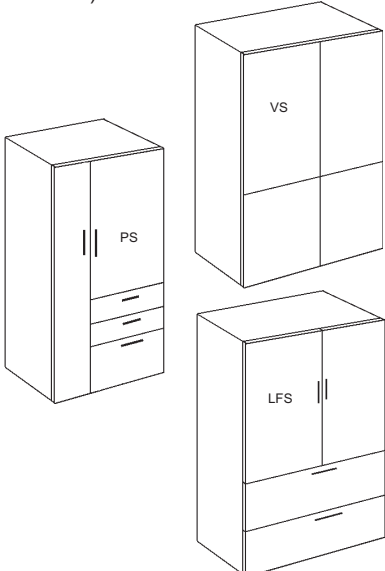



| | | | | | | |
|--|----|----|----|---------|-----|----|
| 21-VS-3872 Door Locks Optional | 20 | 38 | 72 | \$1,102 | 310 | 38 |
| 21-PS-3072 Door Locks Optional (BBF lock not available) Specify right or left (right shown) w/handles (B1) | 20 | 30 | 72 | \$1,680 | 320 | 30 |
| 21-LFS-3872 W/1 lock on LAT Door Locks Optional w/handles (B1) | 20 | 38 | 72 | \$1,496 | 330 | 38 |

Sizes are nominal.

2100 Series

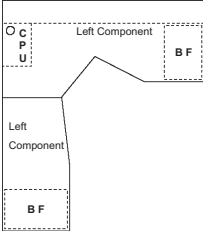
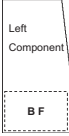
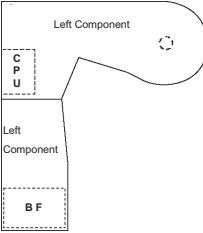
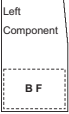
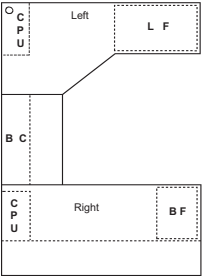
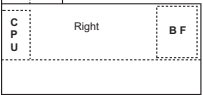
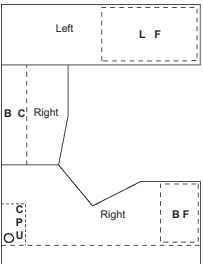
Functional, Contemporary Laminate Designs Offering Clean Lines with Modular Convenience.

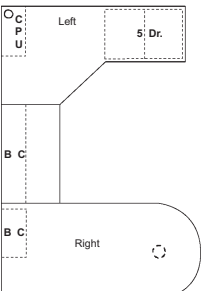
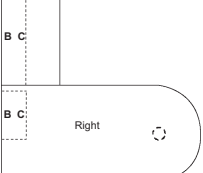
| Groups | | Model Number | Depth | Width | Height | List | Weight | Cube |
|----------|---|--|-------|-------|--------|---------|--------|------|
| Group #1 |  | 21-Group-1 | 83 | 72 | 29 | \$1,640 | 330 | 74 |
| | | <ul style="list-style-type: none"> • 21-CDsp-3672 • 21-ARet-2447 | 36 | 72 | 29 | \$1,026 | 215 | 51 |
| Left |  | | | | | | | |
| | | | | | | | | |
| | | See Components for cut downs | | | | | | |
| Group #2 |  | 21-Group-2 | 83 | 72 | 29 | \$1,432 | 250 | 74 |
| | | <ul style="list-style-type: none"> • 21-CB-3672 • 21-ARet-2447 | 36 | 72 | 29 | \$818 | 135 | 51 |
| Left |  | | | | | | | |
| | | | | | | | | |
| | | See Components for cut downs | | | | | | |
| Group #3 |  | 21-Group-3 | 108 | 72 | 29 | \$2,394 | 575 | 117 |
| | | <ul style="list-style-type: none"> • 21-Dsp-3672 • 21-BR-2036-BC • 21-CCCsp-3672-LF w/1 lock w/handles (B1) | 36 | 72 | 29 | \$712 | 225 | 51 |
| Right |  | | | | | | | |
| | | | | | | | | |
| | | See Components for cut downs | | | | | | |
| Group #4 |  | 21-Group-4 | 92 | 72 | 29 | \$2,504 | 525 | 99 |
| | | <ul style="list-style-type: none"> • 21-CDsp-3672 • 21-ABr-2436-BC • 21-Csp-2072-LF w/1 lock w/handles (B1) | 36 | 72 | 29 | \$1,026 | 215 | 51 |
| Right |  | | | | | | | |
| | | | | | | | | |
| | | See Components for cut downs | | | | | | |
| Group #5 |  | 21-Group-5 | 108 | 72 | 29 | \$2,744 | 490 | 117 |
| | | <ul style="list-style-type: none"> • 21-B-3672 • 21-BR-2036-BC • 21-CCCsp-3672-5DR | 36 | 72 | 29 | \$818 | 140 | 51 |
| Right |  | | | | | | | |
| | | | | | | | | |
| | | See Components for cut downs | | | | | | |

Sizes are nominal.

2100 Series

Functional, Contemporary Laminate Designs Offering Clean Lines with Modular Convenience.

2100

| Groups | | Model Number | Depth | Width | Height | List | Weight | Cube |
|---|--|---|-------|-------|--------|---------|--------|------|
| Group #6 | | 21-Group-6 | 92 | 84 | 29 | \$2,618 | 455 | 107 |
| | | <ul style="list-style-type: none"> • 21-CB-3684 • 21-ABr-2436-BC • 21-Csp-2072-5DR w/handles (B1) Cylinder MOD Optional | 36 | 84 | 29 | \$1,026 | 145 | 59 |
| Group #7 | | 21-Group-7 | 114 | 84 | 29 | \$3,156 | 540 | 134 |
| | | <ul style="list-style-type: none"> • 21-P-3684 • 21-BR-2036-BC • 21-CCCsp-3672-5DR w/handles (B1) Cylinder MOD Optional | 42 | 84 | 29 | \$1,230 | 190 | 68 |
| Group #8 | | 21-Group-8 | 104 | 84 | 29 | \$2,822 | 480 | 126 |
| | | <ul style="list-style-type: none"> • 21-CP-3684 • 21-ABr-2436-BC • 21-Csp-2072-5DR w/handles (B1) Cylinder MOD Optional | 48 | 84 | 29 | \$1,230 | 170 | 78 |
| Group #9 | | 21-Group-9 | 114 | 72 | 29 | \$2,708 | 605 | 117 |
| | | <ul style="list-style-type: none"> • 21-FDsp-3672 • 21-BR-2036-BC • 21-CCCsp-3672-LF w/1 lock w/handles (B1) | 42 | 72 | 29 | \$1,026 | 255 | 59 |
| Computer Corner with Return (CR) | | 21-CR-3666-2042 | 78 | 66 | 29 | \$1,210 | 290 | 65 |
| | | <ul style="list-style-type: none"> • 21-CCCsp-3666 • 21-Ret-2042 | 36 | 66 | 29 | \$780 | 205 | 47 |
| Computer Corner with Return (CR) | | 21-CR-3672-2447 | 83 | 72 | 29 | \$1,434 | 335 | 74 |
| | | <ul style="list-style-type: none"> • 21-CCDsp-3672 • 21-Ret-2447 | 36 | 72 | 29 | \$890 | 215 | 51 |
| | | See Components for cut downs | | | | | | |

Sizes are nominal.

2100 Series

Functional, Contemporary Laminate Designs Offering Clean Lines with Modular Convenience.

How to Specify Left or Right Components

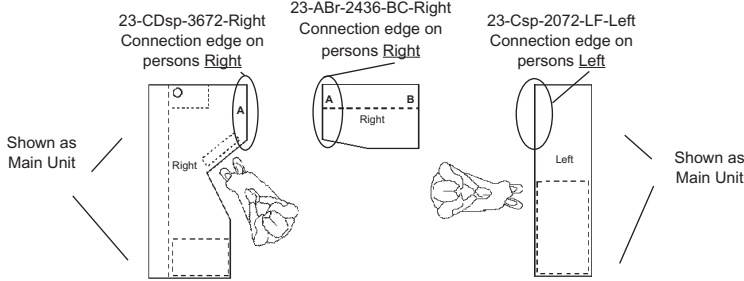

“Right” = Connects to Right side of main desk.

“Left” = Connects to Left side of main desk.

“A” = 20” Width

“B” = 24” Width

Componets

| | Model Number | Depth | Width | Height | List | Weight | Cube | |
|-----------------------------|--|--|-------|--------|---------|--------|------|--|
| Desk Tops | 21-Dsp-3060 | 30 | 60 | 29 | \$624 | 195 | 36 | |
| | 21-Dsp-3066 | 30 | 66 | 29 | \$684 | 215 | 40 | |
| | 21-Dsp-3672 | 36 | 72 | 29 | \$712 | 225 | 51 | |
| | \$176 List to add 6" increments (\$122 List cut downs) | | | | | | | |
| | 21-CDsp-3672 | 36 | 72 | 29 | \$1,026 | 215 | 51 | |
| Fan Tops | 21-FDsp-3066 | 36 | 66 | 29 | \$970 | 240 | 51 | |
| | 21-FDsp-3672 | 42 | 72 | 29 | \$1,026 | 255 | 59 | |
| | | \$210 List to add 6" increments (\$176 List cut downs) | | | | | | |
| | 21-FCDsp-3672 | 42 | 72 | 29 | \$1,092 | 250 | 59 | |
| Bullet Tops | 21-B-3060 | 30 | 60 | 29 | \$698 | 125 | 36 | |
| | 21-B-3066 | 30 | 66 | 29 | \$818 | 130 | 40 | |
| | 21-B-3072 | 30 | 72 | 29 | \$818 | 135 | 43 | |
| | 21-B-3666 | 36 | 66 | 29 | \$818 | 135 | 47 | |
| | 21-B-3672 | 36 | 72 | 29 | \$818 | 140 | 51 | |
| | 21-B-3684 | 36 | 84 | 29 | \$1,026 | 155 | 59 | |
| | | Cylinder MOD Optional | | | | | | |
| | | \$210 List to add 6" increments (\$176 List cut downs) | | | | | | |
| Computer Bullet Tops | 21-CB-3672 | 36 | 72 | 29 | \$818 | 135 | 51 | |
| | 21-CB-3684 | 36 | 84 | 29 | \$1,026 | 145 | 59 | |
| | | Cylinder MOD Optional | | | | | | |
| P-Tops | 21-P-3072 | 36 | 72 | 29 | \$1,026 | 170 | 51 | |
| | 21-P-3672 | 42 | 72 | 29 | \$1,026 | 180 | 59 | |
| | 21-P-3684 | 42 | 84 | 29 | \$1,230 | 190 | 68 | |
| | | Cylinder MOD Optional | | | | | | |
| | \$210 List to add 6" increments (\$176 List cut downs) | | | | | | | |

Sizes are nominal.

2100 Series

Functional, Contemporary Laminate Designs Offering Clean Lines with Modular Convenience.

2100

Computer P-Tops

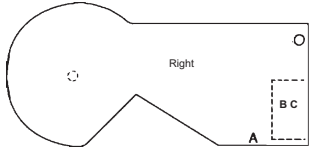

Computer Corners & Credenzas

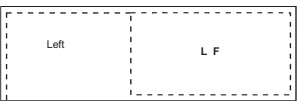
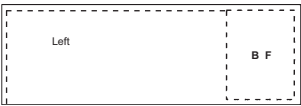
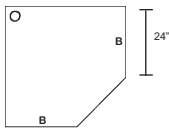
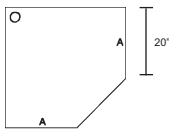
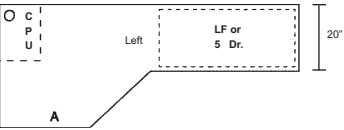
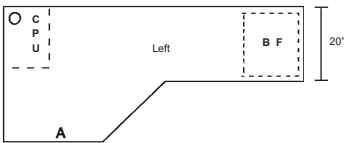
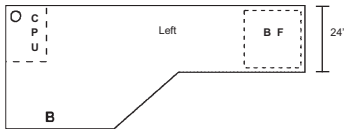



| Model Number | Depth | Width | Height | List | Weight | Cube |
|--|-------|-------|--------|---------|--------|------|
| 21-CP-3672 | 48 | 72 | 29 | \$1,026 | 160 | 67 |
| 21-CP-3684 | 48 | 84 | 29 | \$1,230 | 170 | 78 |
| Cylinder MOD Optional | | | | | | |
| 21-CCDsp-3672 | 36 | 72 | 29 | \$890 | 215 | 51 |
| 21-CCCsp-3660 | 36 | 60 | 29 | \$780 | 190 | 43 |
| 21-CCCsp-3666 | 36 | 66 | 29 | \$780 | 205 | 47 |
| 21-CCCsp-3672 | 36 | 72 | 29 | \$890 | 215 | 51 |
| 21-CCCsp-3672-LF w/1 lock w/handles (B1) | 36 | 72 | 29 | \$1,336 | 250 | 51 |
| 21-CCCsp-3672-5DR w/handles (B1) | 36 | 72 | 29 | \$1,580 | 250 | 51 |
| \$210 List to add 6" increments (\$176 List cut downs) | | | | | | |
| 21-CC-3636-20 | 36 | 36 | 29 | \$516 | 135 | 26 |
| 21-CC-4242-20 | 42 | 42 | 29 | \$556 | 175 | 35 |
| 21-CC-3636-24 | 36 | 36 | 29 | \$516 | 135 | 26 |
| 21-CC-4242-24 | 42 | 42 | 29 | \$556 | 175 | 35 |
| 21-Csp-2060 | 20 | 60 | 29 | \$624 | 170 | 25 |
| 21-Csp-2072 | 20 | 72 | 29 | \$712 | 182 | 30 |
| 21-Csp-2060-LF w/1 lock | 20 | 60 | 29 | \$1,096 | 195 | 25 |
| 21-Csp-2072-LF w/1 lock w/handles (B1) | 20 | 72 | 29 | \$1,096 | 205 | 30 |
| 21-Csp-2060-5DR w/handles (B1) | 20 | 60 | 29 | \$1,210 | 195 | 25 |
| 21-Csp-2072-5DR w/handles (B1) | 20 | 72 | 29 | \$1,210 | 205 | 30 |
| \$176 List to add 6" increments (\$122 List cut downs) | | | | | | |

Sizes are nominal.

2100 Series

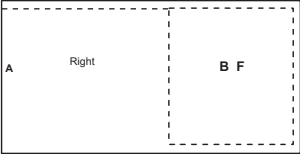
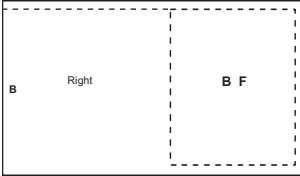
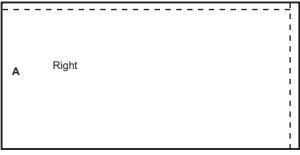
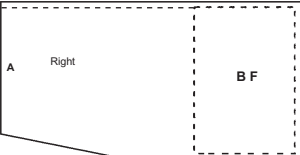
Functional, Contemporary Laminate Designs Offering Clean Lines with Modular Convenience.

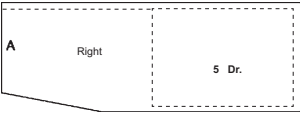
| | Model Number | Depth | Width | Height | List | Weight | Cube |
|--|--|-------|-------|--------|---------|--------|------|
| Returns-20" W/BF Pedestals  | 21-Ret-2036 | 20 | 36 | 29 | \$420 | 80 | 15 |
| | 21-Ret-2042 | 20 | 42 | 29 | \$430 | 85 | 18 |
| | 21-Ret-2047 | 20 | 47 | 29 | \$440 | 95 | 20 |
| | 21-Ret-2054 | 20 | 54 | 29 | \$468 | 100 | 23 |
| | 21-Ret-2060 | 20 | 60 | 29 | \$496 | 105 | 25 |
| | 21-Ret-2066 | 20 | 66 | 29 | \$538 | 110 | 27 |
| | 21-Ret-2072 | 20 | 72 | 29 | \$570 | 115 | 30 |
| | \$176 List to add 6" increments (\$122 List cut downs) | | | | | | |
| Returns-24" W/BF Pedestals  | 21-Ret-2436 | 24 | 36 | 29 | \$490 | 100 | 18 |
| | 21-Ret-2442 | 24 | 42 | 29 | \$516 | 110 | 21 |
| | 21-Ret-2447 | 24 | 47 | 29 | \$544 | 120 | 23 |
| | 21-Ret-2454 | 24 | 54 | 29 | \$614 | 125 | 27 |
| | 21-Ret-2460 | 24 | 60 | 29 | \$636 | 130 | 29 |
| | 21-Ret-2466 | 24 | 66 | 29 | \$650 | 140 | 32 |
| | 21-Ret-2472 | 24 | 72 | 29 | \$662 | 150 | 35 |
| \$176 List to add 6" increments (\$122 List cut downs) | | | | | | | |
| Returns-20" W/No Pedestals  | 21-Ret-2036-NP | 20 | 36 | 29 | \$214 | 60 | 15 |
| | 21-Ret-2042-NP | 20 | 42 | 29 | \$238 | 67 | 18 |
| | 21-Ret-2047-NP | 20 | 47 | 29 | \$246 | 75 | 20 |
| | 21-Ret-2054-NP | 20 | 54 | 29 | \$266 | 80 | 23 |
| | 21-Ret-2060-NP | 20 | 60 | 29 | \$328 | 85 | 25 |
| | 21-Ret-2066-NP | 20 | 66 | 29 | \$350 | 90 | 27 |
| | 21-Ret-2072-NP | 20 | 72 | 29 | \$386 | 97 | 30 |
| | \$176 List to add 6" increments (\$122 List cut downs) | | | | | | |
| Angled Returns-24" W/BF Pedestals  | 21-ARet-2436 | 24 | 36 | 29 | \$514 | 100 | 18 |
| | 21-ARet-2442 | 24 | 42 | 29 | \$544 | 110 | 21 |
| | 21-ARet-2447 | 24 | 47 | 29 | \$614 | 115 | 23 |
| | 21-ARet-2454 | 24 | 54 | 29 | \$636 | 120 | 27 |
| | 21-ARet-2460 | 24 | 60 | 29 | \$650 | 125 | 29 |
| | 21-ARet-2466 | 24 | 66 | 29 | \$660 | 135 | 32 |
| | 21-ARet-2472 | 24 | 72 | 29 | \$672 | 140 | 35 |
| | \$210 List to add 6" increments (\$176 List cut downs) | | | | | | |
| Angled Returns-24" W/LF Pedestals  | 21-ARet-2460-LF w/1 lock | 24 | 60 | 29 | \$1,170 | 215 | 29 |
| | 21-ARet-2472-LF w/1 lock w/handles (B1) | 24 | 72 | 29 | \$1,170 | 225 | 35 |
| \$210 List to add 6" increments (\$176 List cut downs) | | | | | | | |
| Angled Returns-24" W/5DR Pedestals  | 21-ARet-2460-5DR w/handles (B1) | 24 | 60 | 29 | \$1,406 | 215 | 29 |
| | 21-ARet-2472-5DR w/handles (B1) | 24 | 72 | 29 | \$1,406 | 225 | 35 |
| \$210 List to add 6" increments (\$176 List cut downs) | | | | | | | |

Sizes are nominal.

2100 Series

Functional, Contemporary Laminate Designs Offering Clean Lines with Modular Convenience.

2100

Rectangular Bridges W/Bookcase

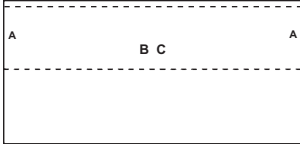

Angled Bridge-24" W/Bookcase

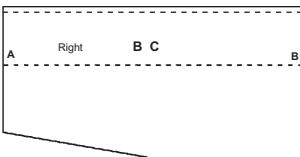

Racetrack Conference Table (RACE)

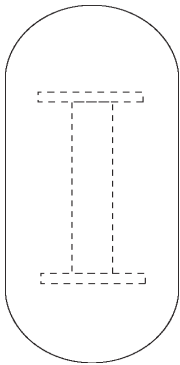

Boat Shape Conference Table (BOAT)

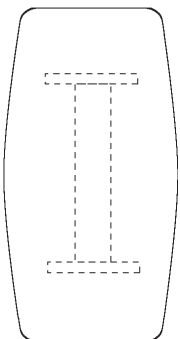

| Model Number | Depth | Width | Height | List | Weight | Cube |
|--|-------|-------|--------|---------|--------|------|
| 21-BR-2036-BC | 20 | 36 | 29 | \$346 | 100 | 15 |
| 21-BR-2042-BC | 20 | 42 | 29 | \$360 | 105 | 18 |
| 21-BR-2047-BC | 20 | 47 | 29 | \$388 | 110 | 20 |
| 21-BR-2447-BC * | 24 | 47 | 29 | \$444 | 120 | 23 |
| 21-BR-2054-BC | 20 | 54 | 29 | \$416 | 115 | 23 |
| 21-BR-2060-BC | 20 | 60 | 29 | \$444 | 120 | 25 |
| 21-BR-2066-BC | 20 | 66 | 29 | \$472 | 125 | 27 |
| 21-BR-2072-BC | 20 | 72 | 29 | \$500 | 130 | 30 |
| \$176 List to add 6" increments (\$122 List cut downs) | | | | | | |
| 21-ABr-2436-BC | 24 | 36 | 29 | \$382 | 105 | 18 |
| 21-ABr-2442-BC | 24 | 42 | 29 | \$430 | 110 | 21 |
| 21-ABr-2447-BC | 24 | 47 | 29 | \$440 | 115 | 23 |
| 21-ABr-2454-BC | 24 | 54 | 29 | \$468 | 120 | 27 |
| 21-ABr-2460-BC | 24 | 60 | 29 | \$496 | 125 | 29 |
| 21-ABr-2466-BC | 24 | 66 | 29 | \$538 | 130 | 32 |
| 21-ABr-2472-BC | 24 | 72 | 29 | \$570 | 135 | 35 |
| \$210 List to add 6" increments (\$176 List cut downs) | | | | | | |
| 21-3672-Race | 36 | 72 | 29 | \$774 | 135 | 23 |
| • 21-3672-Race-TOP | 36 | 72 | 2 | \$612 | 85 | 7 |
| • 21-3672-Rec-Boat-BASE | 24 | 31 | 29 | \$162 | 50 | 16 |
| 21-4896-Race | 48 | 96 | 29 | \$1,010 | 198 | 39 |
| • 21-4896-Race-TOP | 48 | 96 | 2 | \$800 | 143 | 12 |
| • 21-4896-Rec-Boat-BASE | 24 | 55 | 29 | \$210 | 55 | 27 |
| 21-48120-Race | 48 | 120 | 29 | \$1,290 | 252 | 54 |
| • 21-48120-Race-TOP | 48 | 120 | 2 | \$1,020 | 177 | 15 |
| • 21-48120-Rec-Boat-BASE | 24 | 81 | 29 | \$270 | 75 | 39 |
| 21-48144-Race | 48 | 144 | 29 | \$1,876 | 312 | 69 |
| • 21-48144-Race-TOP | 48 | 144 | 2 | \$1,484 | 212 | 17 |
| • 21-48144-Rec-Boat-BASE | 24 | 108 | 29 | \$392 | 100 | 52 |
| Top 2-Piece Base 2-Piece | | | | | | |
| \$298 List to add 12" increments (\$210 List cut downs) add 50% for 60" wide | | | | | | |
| 21-3672-Boat | 36 | 72 | 29 | \$646 | 135 | 23 |
| • 21-3672-Boat-TOP | 36 | 72 | 2 | \$484 | 85 | 7 |
| • 21-3672-Rec-Boat-BASE | 24 | 31 | 29 | \$162 | 50 | 16 |
| 21-4896-Boat | 48 | 96 | 29 | \$978 | 198 | 39 |
| • 21-4896-Boat-TOP | 48 | 96 | 2 | \$768 | 143 | 12 |
| • 21-4896-Rec-Boat-BASE | 24 | 55 | 29 | \$210 | 55 | 27 |
| 21-48120-Boat | 48 | 120 | 29 | \$1,074 | 252 | 54 |
| • 21-48120-Boat-TOP | 48 | 120 | 2 | \$804 | 177 | 15 |
| • 21-48120-Rec-Boat-BASE | 24 | 81 | 29 | \$270 | 75 | 39 |
| 21-48144-Boat | 48 | 144 | 29 | \$1,564 | 312 | 69 |
| • 21-48144-Boat-TOP | 48 | 144 | 2 | \$1,172 | 212 | 17 |
| • 21-48144-Rec-Boat-Base | 24 | 108 | 29 | \$392 | 100 | 52 |
| Top 2-Piece Base 2-Piece | | | | | | |
| \$298 List to add 12" increments (\$210 List cut downs) add 50% for 60" wide | | | | | | |

Sizes are nominal.

*24in deep

2100 Series

Functional, Contemporary Laminate Designs Offering Clean Lines with Modular Convenience.

Rectangular Conference Table (REC)

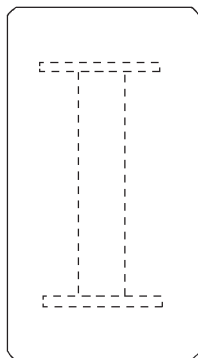

Round Conference Table (RND)

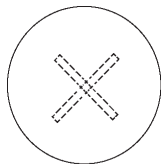

Cylinder Bases

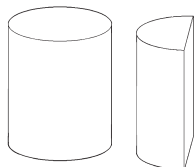

Conference Cabinet (CFC)

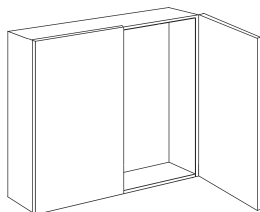

| Model Number | Depth | Width | Height | List | Weight | Cube |
|--|---------|-------|----------|---------|--------|------|
| 21-3672-Rec | 36 | 72 | 29 | \$646 | 135 | 23 |
| • 21-3672-Rec-TOP | 36 | 72 | 2 | \$484 | 85 | 7 |
| • 21-3672-Rec-Boat-BASE | 24 | 31 | 29 | \$162 | 50 | 16 |
| 21-4896-Rec | 48 | 96 | 29 | \$978 | 198 | 39 |
| • 21-4896-Rec-TOP | 48 | 96 | 2 | \$768 | 143 | 12 |
| • 21-4896-Rec-Boat-BASE | 24 | 55 | 29 | \$210 | 55 | 27 |
| 21-48120-Rec | 48 | 120 | 29 | \$1,074 | 252 | 54 |
| • 21-48120-Rec-TOP | 48 | 120 | 2 | \$804 | 177 | 15 |
| • 21-48120-Rec-Boat-BASE | 24 | 81 | 29 | \$270 | 75 | 39 |
| 21-48144-Rec | 48 | 144 | 29 | \$1,564 | 312 | 69 |
| • 21-48144-Rec-TOP | 48 | 144 | 2 | \$1,172 | 212 | 17 |
| • 21-48144-Rec-Boat-Base | 24 | 108 | 29 | \$392 | 100 | 52 |
| Top 2-Piece Base 2-Piece | | | | | | |
| \$298 List to add 12" increments (\$210 List cut downs) | add 50% | for | 60" wide | | | |
| 21-36-RND | 36 | 36 | 29 | \$496 | 100 | 17 |
| • 21-36-RND-Top | 36 | 36 | 2 | \$362 | 62 | 4 |
| • 21-X-Base | 24 | 24 | 29 | \$134 | 38 | 13 |
| 21-42-RND | 42 | 42 | 29 | \$692 | 118 | 18 |
| • 21-42-RND-Top | 42 | 42 | 2 | \$558 | 80 | 5 |
| • 21-X-Base | 24 | 24 | 29 | \$134 | 38 | 13 |
| 21-48-RND | 48 | 48 | 29 | \$692 | 128 | 19 |
| • 21-48-RND-Top | 48 | 48 | 2 | \$558 | 90 | 6 |
| • 21-X-Base | 24 | 24 | 29 | \$134 | 38 | 13 |
| add 50% for 60" | | | | | | |
| • 21-Cylinder Base | 18 | 18 | 27 | \$488 | 25 | 10 |
| • 21-1/2 Cylinder Base | 18 | 9 | 27 | \$488 | 18 | 6 |
| All Tables w/Cylinder Base Must Be Ordered in Component Pieces | | | | | | |
| add 50% for 30" | | | | | | |
| 21-CFC-3636 | 5 | 36 | 36 | \$1,364 | 50 | 6 |
| 21-CFC-4848 | 5 | 48 | 48 | \$1,364 | 75 | 11 |

Sizes are nominal.

2100 Series

Functional, Contemporary Laminate Designs Offering Clean Lines with Modular Convenience.

2100

Lectern (LT)

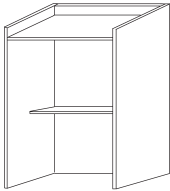

| Model Number | Depth | Width | Height | List | Weight | Cube |
|--------------|-------|-------|--------|-------|--------|------|
| 21-LT-2030 | 20 | 30 | 46 | \$828 | 95 | 15 |

Wall Hanging Overhead (OH)

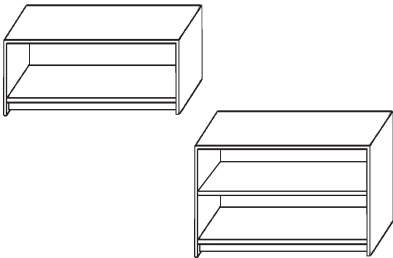

| | | | | | | |
|------------|----|----|----|-------|-----|----|
| 21-OH-1634 | 14 | 34 | 16 | \$586 | 70 | 7 |
| 21-OH-3034 | 15 | 34 | 28 | \$782 | 130 | 11 |

Stand Alone Pedestals (PED)

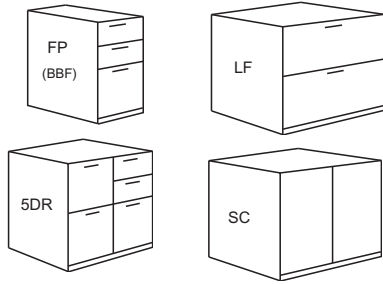

Doors not standard See options for door configurations

| | | | | | | |
|-------------------------------------|----|----|----|-------|----|----|
| 21-PED-2017-FP-SA | 19 | 17 | 27 | \$526 | 45 | 7 |
| Specify - Box/Box/File or File/File | | | | | | |
| 21-PED-2036-LF-SA w/handles (B1) | 19 | 36 | 27 | \$588 | 65 | 14 |
| 21-PED-2033-5DR-SA w/handles (B1) | 19 | 33 | 27 | \$880 | 70 | 13 |
| 21-PED-2036-SC-SA | 19 | 36 | 27 | \$588 | 65 | 14 |

Note - Peds have unfinished backs
See hardware for casters
Adding casters will make unit 29 high

Built in Printer and CPU Pullouts (PPO, CPU)

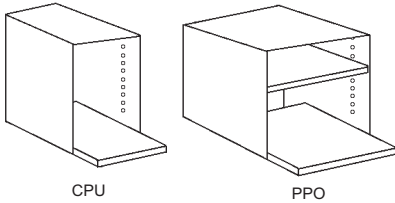

| | | | | | | |
|---|----|----|----|-------|----|--|
| 21-PPO-20 | 19 | 22 | 20 | \$284 | 15 | |
| 21-CPU-PO-20 | 19 | 12 | 20 | \$252 | 10 | |
| 20" depth units only | | | | | | |
| 21-PPO-24 | 23 | 22 | 24 | \$284 | 17 | |
| 21-CPU-PO-24 | 23 | 12 | 24 | \$252 | 12 | |
| 24", 30", 36" depth units only | | | | | | |
| Must be added to no ped, full ped, or lat file units only | | | | | | |

Built in Pedestals (PED)

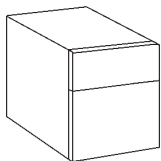

Doors not standard See options for doors

| | | | | | | |
|----------------------------|----|----|----|--------|-----|--|
| 21-PED-2017-BF-BI add ped | 19 | 17 | 18 | \$240 | 30 | |
| remove ped | | | | -\$176 | -30 | |
| 21-PED-2036-LF-BI add ped | 19 | 36 | 27 | \$588 | 65 | |
| 21-PED-2032-5DR-BI add ped | 19 | 33 | 24 | \$824 | 70 | |

Space Limitations Apply
See Options for full ped upcharge

Sizes are nominal.

2100 Series

Functional, Contemporary Laminate Designs Offering Clean Lines with Modular Convenience.

| | Model Number | Depth | Width | Height | List | Weight | Cube |
|--|---|-------|-------|--------|-------|--------|------|
| OPTIONS: | | | | | | | |
| Center Drawer Large | Op-LAM-CD-Large | 20 | 26 | 3 | \$110 | 4 | 2 |
| Center Drawer Small | Op-LAM-CD-Small | 20 | 20 | 3 | \$110 | 4 | 2 |
| Full Pedestal With Lock File File Configuration Or Box Box File Configuration (Includes Full Modesty) | Op-FULL PED | | | | \$212 | 15 | |
| 1/2 Cylinder Base with Full Modesty Panel | Op-Cylinder MOD | | | | \$488 | 40 | |
| Hutch Doors | 21-H-Half Laminate Doors | 1 | | 13 | \$210 | 10 | |
| | 21-CH-Half Laminate Doors | 1 | | 13 | \$210 | 10 | |
| | 21-H-Full Glass Doors | 1 | | 26 | \$856 | 20 | |
| | 21-CH-Full Glass Doors | 1 | | 26 | \$856 | 20 | |
| | 21-H-Upper Half Glass Doors | 1 | | 13 | \$708 | 10 | |
| | 21-CH-Upper Half Glass Doors | 1 | | 13 | \$708 | 10 | |
| Printer and CPU Doors | 21-CPU-Door | 1 | 12 | 24 | \$78 | 3 | |
| | 21-PPO-Door | 1 | 21 | 24 | \$78 | 4 | |
| Overhead Doors | Op-OH-Doors | 1 | | 13 | \$105 | 5 | |
| Full Modesty Panel | Op-FULL MOD | | | | \$78 | 10 | |
| COLORS: | | | | | | | |
| Cherry | LCH | | | | | | |
| Dark Cherry | LDC | | | | | | |
| Mahogany | LMA | | | | | | |
| Medium Oak | LMO | | | | | | |
| Walnut | LWA | | | | 5% | | |
| Maple | LMP | | | | | | |
| Folk Stone | LFS (Base only) | | | | | | |
| Slate Grey | LSL (Base only) | | | | | | |
| Black | LBL (Base only) | | | | | | |
| Mixed Colors (Additional Up Charge) | | | | | 5% | | |
| High Pressure Tops | Includes choice from most colors by: Formica, Nevamar, Pionite, & Wilsonart | | | | 20% | | |
| Touch-up Crayons (in all colors) | Specify Color | | | | \$16 | | |
| Touch-up Markers (in all colors) | Specify Color | | | | \$22 | | |

Sizes are nominal.

2100 Series

Functional, Contemporary Laminate Designs Offering Clean Lines with Modular Convenience.



2100

| | Model Number | Description | List |
|------------------------|-------------------|--|-------|
| Grommet | Op-Grom | (Installed) Hardware, Grommet, 60mm Cable, Black | \$62 |
| | Op-Pwr-Grom | Retractable Power Grommet black | \$434 |
| Powered Grommet | Op-IL-RJ11-Cat. 3 | In-line data module, RJ 11Cat. 3 black | \$48 |
| | Op-IL-RJ45-Cat. 3 | In-line data module, RJ 45 Cat. 3 black | \$48 |
| | Op-HW-RJ11-Cat. 3 | Hard wire data module, RJ 11 Cat. 3 black | \$48 |
| | Op-HW-RJ45-Cat. 3 | Hard wire data module, RJ 45 Cat. 3 black | \$48 |
| | Op-HW-RJ45-Cat. 5 | Hard wire data module, RJ 45 Cat. 5 black | \$48 |
| | Op-HW-RJ45-Cat. 6 | Hard wire data module, RJ 45 Cat. 6 orange | \$82 |

Power Grommets Holds 1 or 2 Data Modules Only.

Grommet Placement Guide

When choosing an optional grommet, please use the drawings below to determine where you would like the grommet placed on the worksurface. For grommet placement in the modesty panels, place an "M" ahead of the number. Grommets through modesty panels are positioned at the highest possible point on the modesty panel. For example: To have the grommet placed in the center of the modesty panel of a return, indicate "M1" on the order line for that item.

Please Note: Grommets cannot go through pedestals on 20" depth units.

Single Pedestal Right

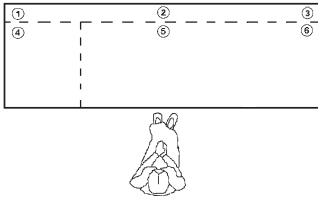

Single Pedestal Left

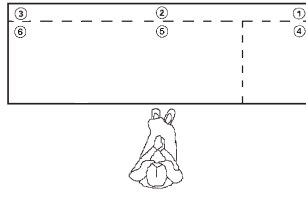

Double Pedestal

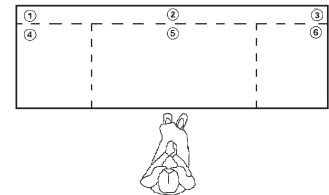

Computer Corner Credenzas

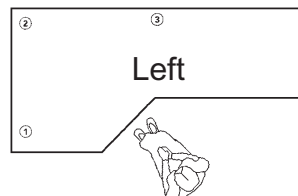
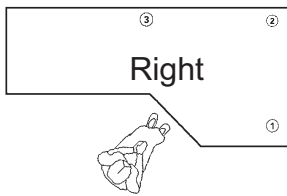

Credenzas

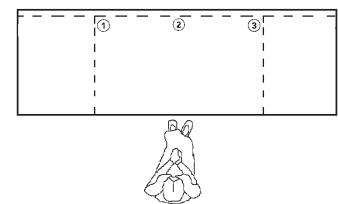

Return Right

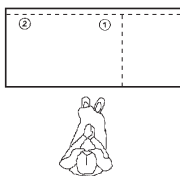

Return Left

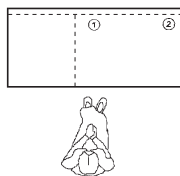

Conference Tables

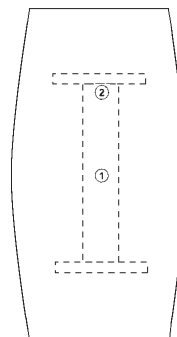

Bullet/P-tops

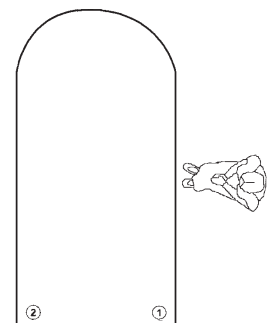

Computer Corner

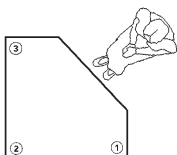

Bridges

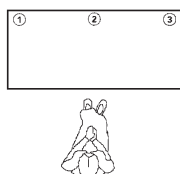

2100 Series

Functional, Contemporary Laminate Designs Offering Clean Lines with Modular Convenience.



Crescent Pull



Wire Pull



Button Pull



Tab Pull



Standard Pull



Traditional Pull



| Model Number | Description | Width | Height | Depth | List |
|--------------|--------------------------|-------|--------|-------|------|
| Op-B1 | Standard Pull Black | 278mm | 18mm | 10mm | \$38 |
| Op-N1 | Standard Pull Nickel | 278mm | 18mm | 10mm | \$38 |
| Op-B2 | Tab Pull Black | 40mm | 26mm | 8mm | \$38 |
| Op-N2 | Tab Pull Nickel | 40mm | 26mm | 8mm | \$38 |
| Op-B3 | Wire Pull Black | 153mm | 30mm | 10mm | \$38 |
| Op-N3 | Wire Pull Nickel | 153mm | 30mm | 10mm | \$38 |
| Op-B4 | Button Pull Black | 31mm | 28mm | 15mm | \$38 |
| Op-N4 | Button Pull Nickel | 31mm | 28mm | 15mm | \$38 |
| Op-B5 | Crescent Pull Black | 100mm | 24mm | 22mm | \$38 |
| Op-N5 | Crescent Pull Nickel | 100mm | 24mm | 22mm | \$38 |
| Op-A6 | Traditional Pull Antique | 147mm | 48mm | 14mm | \$38 |

HARDWARE:

| | | Depth | Width | Height | List | Weight | Cube |
|---|--|-------|-------|--------|-------|--------|------|
| Standard Keyboard Tray | KBT-Standard | 20 | 22 | 2 | \$118 | 10 | 2 |
| Standard Keyboard Tray With Mouse Tray | KBT-Standard-MT | 20 | 22 | 3 | \$196 | 10 | 2 |
| Keyboard Tray With Articulating Arm and Mouse Tray | KBT-ArtArm-MT | 20 | 27 | 4 | \$356 | 10 | 2 |
| Desk Lock | Op-DESK-LOCK | | | | \$62 | | |
| Casters | OP-Casters (add 2" to height) | | | 2 | \$128 | | |
| Cartoning | Corner guards, cardboard top, & sides (Priced per box) | | | | \$74 | | |
| | Bubble Wrap | | | | \$74 | | |
| | Bubble Wrap & Palletize | | | | \$126 | | |

Sizes are nominal.

3100 Series

Functional, Contemporary Laminate Designs Offering Clean Lines with Modular Convenience.

Laminate

Square Edge

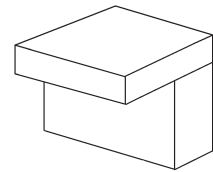

Standard Features:

- Full Suspension on all Drawers.
- Box/Box/File Pedestals w/handles (Op-B1).
- Touch Latch Doors on Credenzas.
- File Drawers Supplied with Rods for Hanging Legal and Letter Files.
- Matching Vertical Grain Drawer Fronts.
- 1/2" 9 Ply UV Coated Birch Drawer Material
- Vertical Grain Modesty Panels
- 20" Depth on Credenzas, Returns, Lateral Files, and Bridges.
- Adjustable Leveling Glides (Except Bookcases).
- Thermofused Laminate on Tops.
- Locks Keyed Alike.

Desks - Double Pedestal/ Single Pedestal/ Fan Desk (DP, FDP, SP)

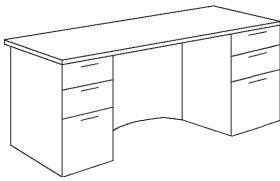

| Model Number | Depth | Width | Height | List | Weight | Cube |
|--|-------|-------|--------|---------|--------|------|
| 31-DP-3060 | 30 | 60 | 29 | \$1,132 | 265 | 36 |
| 31-DP-3066 | 30 | 66 | 29 | \$1,210 | 275 | 40 |
| 31-DP-3672 | 36 | 72 | 29 | \$1,374 | 305 | 51 |
| 31-SP-2448 | 24 | 48 | 29 | \$760 | 135 | 24 |
| 31-SP-3048 | 30 | 48 | 29 | \$950 | 145 | 29 |
| Floating top option available, See options. | | | | | | |
| \$176 List to add 6" increments (\$122 List cut downs) | | | | | | |
| 31-FDP-3066 | 30 | 72 | 29 | \$1,448 | 295 | 51 |
| 31-FDP-3672 | 42 | 72 | 29 | \$1,558 | 325 | 59 |
| Floating top option available, See options. | | | | | | |
| \$210 List to add 6" increments (\$176 List cut downs) | | | | | | |
| 31-C-2060-Cab | 20 | 60 | 29 | \$1,132 | 223 | 25 |
| 31-C-2060-Open | 20 | 60 | 29 | \$1,132 | 205 | 25 |
| 31-C-2066-Cab | 20 | 66 | 29 | \$1,210 | 229 | 27 |
| 31-C-2066-Open | 20 | 66 | 29 | \$1,210 | 211 | 27 |
| 31-C-2072-Cab | 20 | 72 | 29 | \$1,374 | 235 | 30 |
| 31-C-2072-Open | 20 | 72 | 29 | \$1,374 | 217 | 30 |
| Floating top option available, See options. | | | | | | |
| 24" Credenza depth add \$176 List | | | | | | |
| \$176 List to add 6" increments (\$122 List cut downs) | | | | | | |
| 31-DR-3060-2042 | 72 | 60 | 29 | \$1,688 | 280 | 54 |
| • 31-Dsp-3060 | 30 | 60 | 29 | \$1,000 | 195 | 36 |
| • 31-Ret-2042 | 20 | 42 | 29 | \$688 | 85 | 18 |
| 31-DR-3066-2447 | 77 | 66 | 29 | \$1,964 | 335 | 63 |
| • 31-Dsp-3066 | 30 | 66 | 29 | \$1,096 | 215 | 40 |
| • 31-Ret-2447 | 24 | 47 | 29 | \$868 | 120 | 23 |
| 31-DR-3672-2047 | 83 | 72 | 29 | \$1,844 | 320 | 71 |
| • 31-Dsp-3672 | 36 | 72 | 29 | \$1,140 | 225 | 51 |
| • 31-Ret-2047 | 20 | 47 | 29 | \$704 | 95 | 20 |
| 31-DR-3672-2447 | 83 | 72 | 29 | \$2,008 | 345 | 74 |
| • 31-Dsp-3672 | 36 | 72 | 29 | \$1,140 | 225 | 51 |
| • 31-Ret-2447 | 24 | 47 | 29 | \$868 | 120 | 23 |
| 31-FDR-3672-2448 | 89 | 72 | 29 | \$2,192 | 375 | 82 |
| • 31-FDsp-3672 | 42 | 72 | 29 | \$1,324 | 255 | 59 |
| • 31-Ret-2447 | 24 | 47 | 29 | \$868 | 120 | 23 |
| Floating top option available, See options. | | | | | | |
| \$176 List to add 6" increments (\$122 List cut downs) | | | | | | |

Credenzas (C-Open/C-Cab)

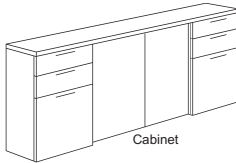

Desks with Return (DR, FDR)

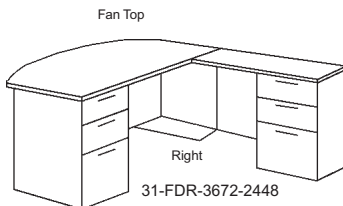
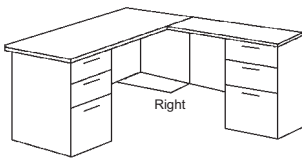

3100

Sizes are nominal.

3100 Series

Functional, Contemporary Laminate Designs Offering Clean Lines with Modular Convenience.

Work Tables (WT)

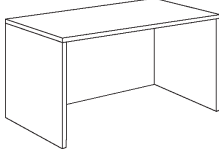

| Model Number | Depth | Width | Height | List | Weight | Cube |
|--------------|-------|-------|--------|-------|--------|------|
| 31-WT-2036 | 20 | 36 | 29 | \$296 | 65 | 15 |
| 31-WT-2042 | 20 | 42 | 29 | \$296 | 85 | 18 |
| 31-WT-2048 | 20 | 48 | 29 | \$318 | 95 | 20 |
| 31-WT-2060 | 20 | 60 | 29 | \$418 | 100 | 25 |
| 31-WT-2072 | 20 | 72 | 29 | \$470 | 115 | 30 |
| 31-WT-2448 | 24 | 48 | 29 | \$318 | 110 | 24 |
| 31-WT-3048 | 30 | 48 | 29 | \$364 | 130 | 29 |
| 31-WT-3060 | 30 | 60 | 29 | \$452 | 140 | 36 |
| 31-WT-3672 | 36 | 72 | 29 | \$542 | 160 | 51 |

Floating top option available, See options.

\$176 List to add 6" increments (\$122 List cut downs)

Lateral Files (LF)

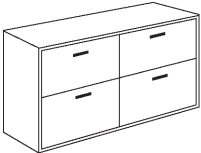

| | | | | | | |
|----------------|----|----|----|---------|-----|----|
| 31-LF-2038-2D | 20 | 38 | 29 | \$588 | 170 | 16 |
| 31-LF-2072-4D | 20 | 72 | 29 | \$1,080 | 330 | 30 |
| Locks Standard | | | | | | |

Floating top option available, See options.

For:

- Bookcases
- Conference Tables
- End Tables
- Hutches
- Reception Units
- Storage Cabinets
- And
- Other Items

See 2100 Series

Sizes are nominal.

3100 Series

Functional, Contemporary Laminate Designs Offering Clean Lines with Modular Convenience.

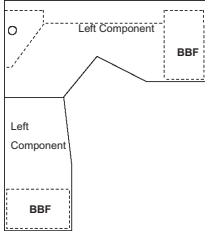
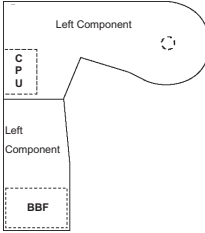
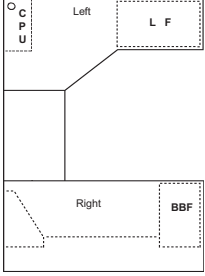
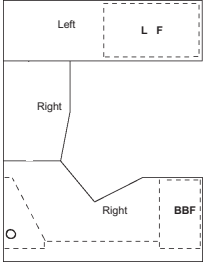
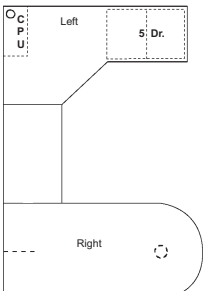
| Groups | | Model Number | Depth | Width | Height | List | Weight | Cube |
|----------|---|---|-------|-------|--------|---------|--------|------|
| Group #1 |  | 31-Group-1 | 83 | 72 | 29 | \$2,306 | 330 | 74 |
| | | <ul style="list-style-type: none"> • 31-CDsp-3672 • 31-ARet-2447 | 36 | 72 | 29 | \$1,324 | 215 | 51 |
| Left | | | | | | | | |
| | | See Components for cut downs | | | | | | |
| | | Floating top option available, See options. | | | | | | |
| Group #2 |  | 31-Group-2 | 83 | 72 | 29 | \$1,984 | 250 | 74 |
| | | <ul style="list-style-type: none"> • 31-CB-3672 • 31-ARet-2447 | 36 | 72 | 29 | \$1,002 | 135 | 51 |
| Left | | | | | | | | |
| | | Cylinder MOD Optional | | | | | | |
| | | See Components for cut downs | | | | | | |
| | | Floating top option available, See options. | | | | | | |
| Group #3 |  | 31-Group-3 | 108 | 72 | 29 | \$2,822 | 575 | 117 |
| | | <ul style="list-style-type: none"> • 31-Dsp-3672 • 31-BR-2036 • 31-CCCsp-3672-LF w/1 lock w/handles (B1) | 36 | 72 | 29 | \$1,140 | 225 | 51 |
| Right | | | | | | | | |
| | | See Components for cut downs | | | | | | |
| | | Floating top option available, See options. | | | | | | |
| Group #4 |  | 31-Group-4 | 92 | 72 | 29 | \$2,802 | 525 | 99 |
| | | <ul style="list-style-type: none"> • 31-CDsp-3672 • 31-ABr-2436 • 31-Csp-2072-LF w/1 lock w/handles (B1) | 36 | 72 | 29 | \$1,324 | 215 | 51 |
| Right | | | | | | | | |
| | | See Components for cut downs | | | | | | |
| | | Floating top option available, See options. | | | | | | |
| Group #5 |  | 31-Group-5 | 108 | 72 | 29 | \$2,928 | 490 | 117 |
| | | <ul style="list-style-type: none"> • 31-B-3672 • 31-BR-2036 • 31-CCCsp-3672-5DR w/handles (B1) | 36 | 72 | 29 | \$1,002 | 140 | 51 |
| Right | | | | | | | | |
| | | Cylinder MOD Optional | | | | | | |
| | | See Components for cut downs | | | | | | |
| | | Floating top option available, See options. | | | | | | |

3100

Sizes are nominal.

3100 Series

Functional, Contemporary Laminate Designs Offering Clean Lines with Modular Convenience.

| Groups | | Model Number | Depth | Width | Height | List | Weight | Cube |
|---|--|--|-------|-------|--------|---------|--------|------|
| Group #6 | | 31-Group-6 | 92 | 84 | 29 | \$2,802 | 455 | 107 |
| | | <ul style="list-style-type: none"> • 31-CB-3684 • 31-ABr-2436-BC • 31-Csp-2072-5DR w/handles (B1) | 36 | 84 | 29 | \$1,210 | 145 | 59 |
| Right | | Cylinder MOD Optional | 24 | 36 | 29 | \$382 | 105 | 18 |
| | | | 20 | 72 | 29 | \$1,210 | 205 | 30 |
| | | See Components for cut downs | | | | | | |
| | | Floating top option available, See options. | | | | | | |
| Group #7 | | 31-Group-7 | 114 | 84 | 29 | \$3,340 | 540 | 134 |
| | | <ul style="list-style-type: none"> • 31-P-3684 • 31-BR-2036-BC • 31-CCCsp-3672-5DR | 42 | 84 | 29 | \$1,414 | 190 | 68 |
| Right | | w/handles (B1) | 20 | 36 | 29 | \$346 | 100 | 15 |
| | | Cylinder MOD Optional | 36 | 72 | 29 | \$1,580 | 250 | 51 |
| | | See Components for cut downs | | | | | | |
| | | Floating top option available, See options. | | | | | | |
| Group #8 | | 31-Group-8 | 104 | 84 | 29 | \$3,006 | 480 | 126 |
| | | <ul style="list-style-type: none"> • 31-CP-3684 • 31-ABr-2436-BC • 31-Csp-2072-5DR | 48 | 84 | 29 | \$1,414 | 170 | 78 |
| Right | | w/handles (B1) | 24 | 36 | 29 | \$382 | 105 | 18 |
| | | Cylinder MOD Optional | 20 | 72 | 29 | \$1,210 | 205 | 30 |
| | | See Components for cut downs | | | | | | |
| | | Floating top option available, See options. | | | | | | |
| Group #9 | | 31-Group-9 | 114 | 72 | 29 | \$3,006 | 605 | 117 |
| | | <ul style="list-style-type: none"> • 31-FDsp-3672 • 31-BR-2036-BC • 31-CCCsp-3672-LF w/1 lock | 42 | 72 | 29 | \$1,324 | 255 | 59 |
| Right | | w/handles (B1) | 20 | 36 | 29 | \$346 | 100 | 15 |
| | | | 36 | 72 | 29 | \$1,336 | 250 | 51 |
| | | See Components for cut downs | | | | | | |
| | | Floating top option available, See options. | | | | | | |
| Computer Corner with Return (CR) | | 31-CR-3666-2042 | 78 | 66 | 29 | \$1,934 | 290 | 65 |
| | | <ul style="list-style-type: none"> • 31-CCCsp-3666 • 31-Ret-2042 | 36 | 66 | 29 | \$1,246 | 205 | 47 |
| Right | | 31-CR-3672-2447 | 83 | 72 | 29 | \$2,292 | 335 | 74 |
| | | <ul style="list-style-type: none"> • 31-CCDsp-3672 • 31-Ret-2447 | 36 | 72 | 29 | \$1,424 | 215 | 51 |
| | | See Components for cut downs | | | | | | |
| | | Floating top option available, See options. | | | | | | |

Sizes are nominal.

3100 Series

Functional, Contemporary Laminate Designs Offering Clean Lines with Modular Convenience.

How to Specify Left or Right Components

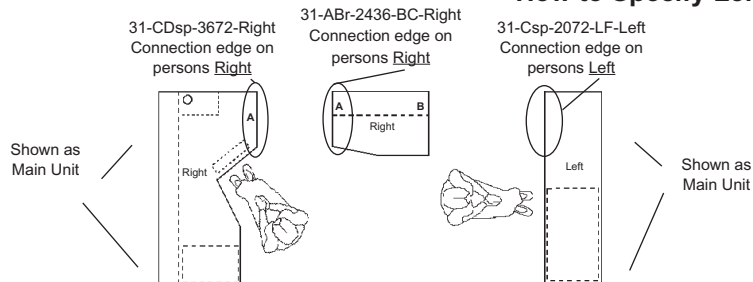

“Right” = Connects to Right side of main desk.

“Left” = Connects to Left side of main desk.

“A” = 20” Width

“B” = 24” Width

Components

Desk Tops

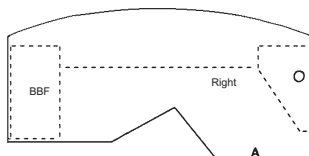
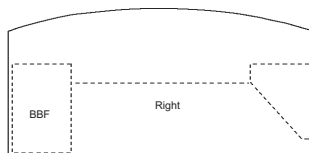
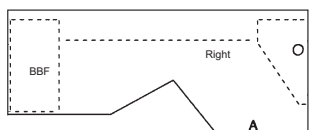
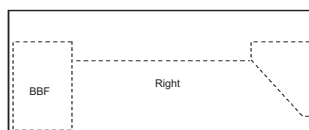

Bullet Tops

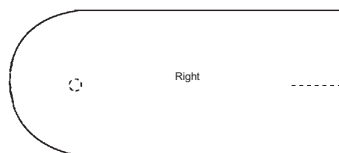

Computer Bullet Tops



P-Tops

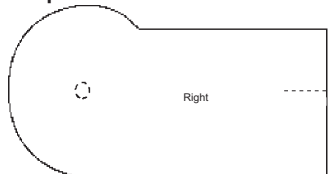

| Model Number | Depth | Width | Height | List | Weight | Cube |
|---|-------|-------|--------|---------|--------|------|
| 31-Dsp-3060 | 30 | 60 | 29 | \$1,000 | 195 | 36 |
| 31-Dsp-3066 | 30 | 66 | 29 | \$1,096 | 215 | 40 |
| 31-Dsp-3672 | 36 | 72 | 29 | \$1,140 | 225 | 51 |
| Floating top option available, See options. \$176 List to add 6" increments (\$122 List cut downs) | | | | | | |
| 31-CDsp-3672 | 36 | 72 | 29 | \$1,324 | 215 | 51 |
| Floating top option available, See options. | | | | | | |
| 31-FDsp-3066 | 36 | 66 | 29 | \$1,268 | 245 | 51 |
| 31-FDsp-3672 | 42 | 72 | 29 | \$1,324 | 255 | 59 |
| Floating top option available, See options. \$210 List to add 6" increments (\$176 List cut downs) | | | | | | |
| 31-FCDsp-3672 | 42 | 72 | 29 | \$1,470 | 250 | 59 |
| Floating top option available, See options. | | | | | | |
| 31-B-3060 | 30 | 60 | 29 | \$882 | 125 | 36 |
| 31-B-3066 | 30 | 66 | 29 | \$1,002 | 130 | 40 |
| 31-B-3072 | 30 | 72 | 29 | \$1,002 | 135 | 43 |
| 31-B-3666 | 36 | 66 | 29 | \$1,002 | 135 | 47 |
| 31-B-3672 | 36 | 72 | 29 | \$1,002 | 140 | 51 |
| 31-B-3684 | 36 | 84 | 29 | \$1,210 | 155 | 59 |
| Cylinder MOD Optional | | | | | | |
| Floating top option available, See options. \$210 List to add 6" increments (\$176 List cut downs) | | | | | | |
| 31-CB-3672 | 36 | 72 | 29 | \$1,002 | 135 | 51 |
| 31-CB-3684 | 36 | 84 | 29 | \$1,210 | 145 | 59 |
| Cylinder MOD Optional | | | | | | |
| Floating top option available, See options. | | | | | | |
| 31-P-3072 | 36 | 72 | 29 | \$1,210 | 170 | 51 |
| 31-P-3672 | 42 | 72 | 29 | \$1,210 | 180 | 59 |
| 31-P-3684 | 42 | 84 | 29 | \$1,414 | 190 | 68 |
| Cylinder MOD Optional | | | | | | |
| Floating top option available, See options. \$210 List to add 6" increments (\$176 List cut downs) | | | | | | |

Sizes are nominal.

3100 Series

Functional, Contemporary Laminate Designs Offering Clean Lines with Modular Convenience.

Computer P-Tops

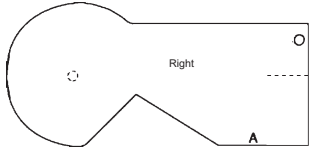

Computer Corners & Credenzas

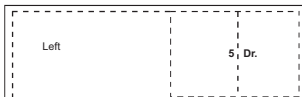
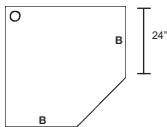
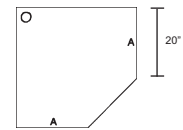
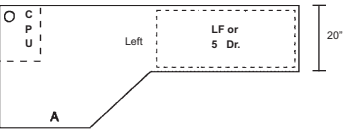
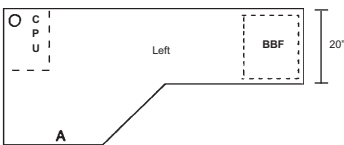
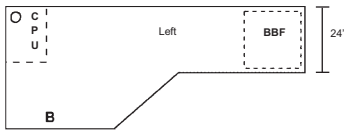



| Model Number | Depth | Width | Height | List | Weight | Cube |
|---|-------|-------|--------|---------|--------|------|
| 31-CP-3672 | 48 | 72 | 29 | \$1,210 | 160 | 67 |
| 31-CP-3684 | 48 | 84 | 29 | \$1,414 | 170 | 78 |
| Cylinder MOD Optional | | | | | | |
| Floating top option available, See options. | | | | | | |
| 31-CCDsp-3672 | 36 | 72 | 29 | \$1,424 | 215 | 51 |
| 31-CCCsp-3660 | 36 | 60 | 29 | \$1,246 | 190 | 43 |
| 31-CCCsp-3666 | 36 | 66 | 29 | \$1,246 | 205 | 47 |
| 31-CCCsp-3672 | 36 | 72 | 29 | \$1,424 | 215 | 51 |
| 31-CCCsp-3672-LF w/1 lock w/handles (B1) | 36 | 72 | 29 | \$1,336 | 250 | 51 |
| 31-CCCsp-3672-5DR w/handles (B1) | 36 | 72 | 29 | \$1,580 | 250 | 51 |
| Floating top option available, See options. \$210 List to add 6" increments (\$176 List cut downs) | | | | | | |
| 31-CC-3636-20 | 36 | 36 | 29 | \$514 | 135 | 26 |
| 31-CC-4242-20 | 42 | 42 | 29 | \$556 | 175 | 35 |
| 31-CC-3636-24 | 36 | 36 | 29 | \$514 | 135 | 26 |
| 31-CC-4242-24 | 42 | 42 | 29 | \$556 | 175 | 35 |
| Floating top option available, See options. | | | | | | |
| 31-Csp-2060 | 20 | 60 | 29 | \$1,000 | 170 | 25 |
| 31-Csp-2072 | 20 | 72 | 29 | \$1,140 | 182 | 30 |
| 31-Csp-2060-LF w/1 lock w/handles (B1) | 20 | 60 | 29 | \$1,096 | 195 | 25 |
| 31-Csp-2072-LF w/1 lock w/handles (B1) | 20 | 72 | 29 | \$1,096 | 205 | 30 |
| 31-Csp-2060-5DR w/handles (B1) | 20 | 60 | 29 | \$1,210 | 195 | 25 |
| 31-Csp-2072-5DR w/handles (B1) | 20 | 72 | 29 | \$1,210 | 205 | 30 |
| Floating top option available, See options. \$176 List to add 6" increments (\$122 List cut downs) | | | | | | |

Sizes are nominal.

3100 Series

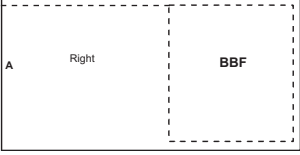
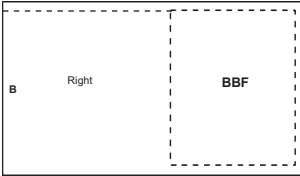
Functional, Contemporary Laminate Designs Offering Clean Lines with Modular Convenience.

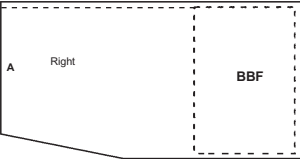
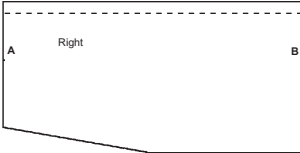
| | Model Number | Depth | Width | Height | List | Weight | Cube |
|--|--|-------|-------|--------|---------|--------|------|
| Returns-20" W/BBF Pedestals  | 31-Ret-2036 | 20 | 36 | 29 | \$670 | 80 | 15 |
| | 31-Ret-2042 | 20 | 42 | 29 | \$688 | 85 | 18 |
| | 31-Ret-2047 | 20 | 47 | 29 | \$704 | 95 | 20 |
| | 31-Ret-2054 | 20 | 54 | 29 | \$748 | 100 | 23 |
| | 31-Ret-2060 | 20 | 60 | 29 | \$794 | 105 | 25 |
| | 31-Ret-2066 | 20 | 66 | 29 | \$860 | 110 | 27 |
| | 31-Ret-2072 | 20 | 72 | 29 | \$910 | 115 | 30 |
| | Floating top option available, See options. | | | | | | |
| \$176 List to add 6" increments (\$122 List cut downs) | | | | | | | |
| Returns-24" W/BBF Pedestals  | 31-Ret-2436 | 24 | 36 | 29 | \$784 | 100 | 18 |
| | 31-Ret-2442 | 24 | 42 | 29 | \$824 | 110 | 21 |
| | 31-Ret-2447 | 24 | 47 | 29 | \$868 | 120 | 23 |
| | 31-Ret-2454 | 24 | 54 | 29 | \$984 | 125 | 27 |
| | 31-Ret-2460 | 24 | 60 | 29 | \$1,018 | 130 | 29 |
| | 31-Ret-2466 | 24 | 66 | 29 | \$1,038 | 140 | 32 |
| | 31-Ret-2472 | 24 | 72 | 29 | \$1,056 | 150 | 35 |
| | Floating top option available, See options. | | | | | | |
| \$176 List to add 6" increments (\$122 List cut downs) | | | | | | | |
| Rectangular Bridges  | 31-BR-2036 | 20 | 36 | 29 | \$346 | 100 | 15 |
| | 31-BR-2042 | 20 | 42 | 29 | \$360 | 105 | 18 |
| | 31-BR-2048 | 20 | 47 | 29 | \$388 | 110 | 20 |
| | 31-BR-2447 * | 24 | 47 | 29 | \$444 | 120 | 23 |
| | 31-BR-2054 | 20 | 54 | 29 | \$416 | 115 | 23 |
| | 31-BR-2060 | 20 | 60 | 29 | \$444 | 120 | 25 |
| | 31-BR-2066 | 20 | 66 | 29 | \$472 | 125 | 27 |
| | 31-BR-2072 | 20 | 72 | 29 | \$500 | 130 | 30 |
| Floating top option available, See options. | | | | | | | |
| \$176 List to add 6" increments (\$122 List cut downs) | | | | | | | |
| Angled Returns-24" W/BBF Pedestals  | 31-ARet-2436 | 24 | 36 | 29 | \$824 | 100 | 18 |
| | 31-ARet-2442 | 24 | 42 | 29 | \$868 | 110 | 21 |
| | 31-ARet-2447 | 24 | 47 | 29 | \$982 | 115 | 23 |
| | 31-ARet-2454 | 24 | 54 | 29 | \$1,018 | 120 | 27 |
| | 31-ARet-2460 | 24 | 60 | 29 | \$1,038 | 125 | 29 |
| | 31-ARet-2466 | 24 | 66 | 29 | \$1,056 | 135 | 32 |
| | 31-ARet-2472 | 24 | 72 | 29 | \$1,076 | 140 | 35 |
| | Floating top option available, See options. | | | | | | |
| \$210 List to add 6" increments (\$176 List cut downs) | | | | | | | |
| Angled Bridge-24"  | 31-ABr-2436 | 24 | 36 | 29 | \$382 | 105 | 18 |
| | 31-ABr-2442 | 24 | 42 | 29 | \$430 | 110 | 21 |
| | 31-ABr-2447 | 24 | 47 | 29 | \$440 | 115 | 23 |
| | 31-ABr-2454 | 24 | 54 | 29 | \$468 | 120 | 27 |
| | 31-ABr-2460 | 24 | 60 | 29 | \$496 | 125 | 29 |
| | 31-ABr-2466 | 24 | 66 | 29 | \$538 | 130 | 32 |
| | 31-ABr-2472 | 24 | 72 | 29 | \$570 | 135 | 35 |
| | \$210 List to add 6" increments (\$176 List cut downs) | | | | | | |

3100

Sizes are nominal.

*24in deep

3100 Series

Functional, Contemporary Laminate Designs Offering Clean Lines with Modular Convenience.

Stand Alone Pedestals (PED)

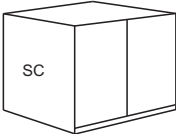
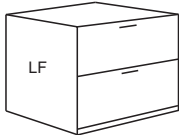
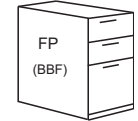

| Model Number | Depth | Width | Height | List | Weight | Cube |
|---------------------------------------|-------|-------|--------|-------|--------|------|
| 21-PED-2017-FP-SA | 19 | 17 | 27 | \$526 | 45 | 7 |
| Specify - Box/Box/File or File/File | | | | | | |
| 21-PED-2036-LF-SA w/handles (B1) | 19 | 36 | 27 | \$588 | 65 | 14 |
| 21-PED-2033-5DR-SA w/handles (B1) | 19 | 33 | 27 | \$880 | 70 | 13 |
| 21-PED-2036-SC-SA | 19 | 36 | 27 | \$588 | 65 | 14 |
| Note - Peds have unfinished backs | | | | | | |
| See hardware for casters | | | | | | |
| Adding casters will make unit 29 high | | | | | | |
| | | | | | | |
| | | | | | | |
| | | | | | | |
| | | | | | | |
| | | | | | | |
| | | | | | | |
| | | | | | | |
| | | | | | | |
| | | | | | | |
| | | | | | | |
| | | | | | | |
| | | | | | | |
| | | | | | | |
| | | | | | | |
| | | | | | | |
| | | | | | | |
| | | | | | | |
| | | | | | | |
| | | | | | | |
| | | | | | | |
| | | | | | | |
| | | | | | | |
| | | | | | | |
| | | | | | | |
| | | | | | | |
| | | | | | | |
| | | | | | | |
| | | | | | | |
| | | | | | | |
| | | | | | | |
| | | | | | | |
| | | | | | | |
| | | | | | | |
| | | | | | | |
| | | | | | | |
| | | | | | | |
| | | | | | | |
| | | | | | | |

Sizes are nominal.

3100 Series

Functional, Contemporary Laminate Designs Offering Clean Lines with Modular Convenience.

| OPTIONS: | Model Number | Depth | Width | Height | List | Weight | Cube |
|---|---|-----------------|-------|--------|-------|--------|------|
| Center Drawer Large | Op-LAM-CD-Large | 20 | 26 | 3 | \$110 | 4 | 2 |
| Center Drawer Small | Op-LAM-CD-Small | 20 | 20 | 3 | \$110 | 4 | 2 |
| 1/2 Cylinder Base with Full Modesty Panel | Op-Cylinder MOD | | | | \$488 | 40 | |
| Perforated Metal Modesty Panel | Op-Metal MOD (Nickel) | | | | \$312 | | |
| | Op-Metal MOD (Black) | | | | \$312 | | |
| Floating Top | Op-Float Top (Nickel) (per piece) | | | 2 | \$368 | | |
| | Op-Float Top (Black) (per piece) | | | 2 | \$368 | | |
| Convert Box/Box/File Ped to File/File Ped | Specify File/File | | | | N/C | | |
| | | | | | | | |
| COLORS: | Cherry | LCH | | | | | |
| | Dark Cherry | LDC | | | | | |
| | Mahogany | LMA | | | | | |
| | Medium Oak | LMO | | | | | |
| | Walnut | LWA | | | | 5% | |
| | Maple | LMP | | | | | |
| | Folk Stone | LFS (Base only) | | | | | |
| | Slate Grey | LSL (Base only) | | | | | |
| | Black | LBL (Base only) | | | | | |
| | Mixed Colors | | | | | | |
| | (Additional Up Charge) | | | | | 5% | |
| High Pressure Tops | Includes choice from most colors by: Formica, Nevamar, Pionite, & Wilsonart | | | | 20% | | |
| | | | | | | | |
| Touch-up Crayons (in all colors) | Specify Color | | | | \$16 | | |
| Touch-up Markers (in all colors) | Specify Color | | | | \$22 | | |

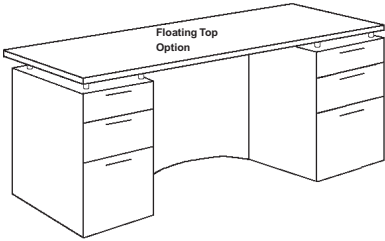

3100

Sizes are nominal.

3100 Series

Functional, Contemporary Laminate Designs Offering Clean Lines with Modular Convenience.



| | Model Number | Description | List |
|--|------------------------|--|---------------------------------|
| Grommet | Op-Grom | (Installed) Hardware, Grommet, 60mm Cable, Black | \$62 |
| | Powered Grommet | Op-Pwr-Grom | Retractable Power Grommet black |
| Power Grommets Holds 1 or 2 Data Modules Only. | Op-IL-RJ11-Cat. 3 | In-line data module, RJ 11Cat. 3 black | \$48 |
| | Op-IL-RJ45-Cat. 3 | In-line data module, RJ 45 Cat. 3 black | \$48 |
| | Op-HW-RJ11-Cat. 3 | Hard wire data module, RJ 11 Cat. 3 black | \$48 |
| | Op-HW-RJ45-Cat. 3 | Hard wire data module, RJ 45 Cat. 3 black | \$48 |
| | Op-HW-RJ45-Cat. 5 | Hard wire data module, RJ 45 Cat. 5 black | \$48 |
| | Op-HW-RJ45-Cat. 6 | Hard wire data module, RJ 45 Cat. 6 orange | \$82 |

Grommet Placement Guide

When choosing an optional grommet, please use the drawings below to determine where you would like the grommet placed on the worksurface. For grommet placement in the modesty panels, place an "M" ahead of the number. Grommets through modesty panels are positioned at the highest possible point on the modesty panel.

For example: To have the grommet placed in the center of the modesty panel of a return, indicate "M1" on the order line for that item.

Please Note: Grommets cannot go through pedestals on 20" depth units.

Single Pedestal Right

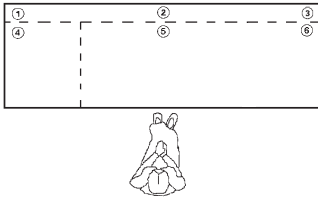

Single Pedestal Left

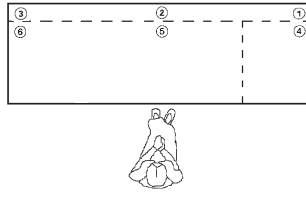

Double Pedestal

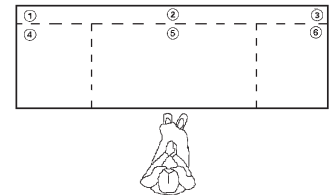

Computer Corner Credenzas

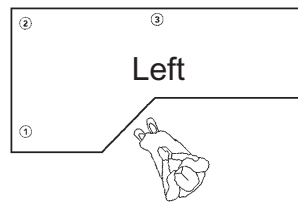
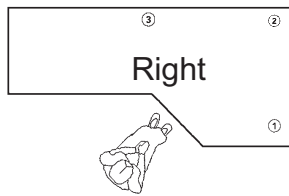

Credenzas

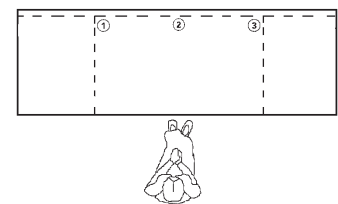

Return Right

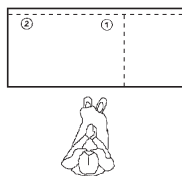

Return Left

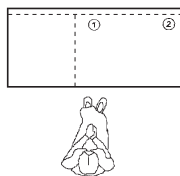

Conference Tables

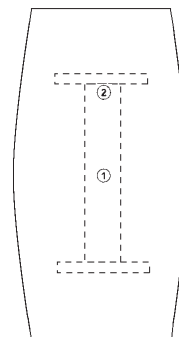

Bullet/P-tops

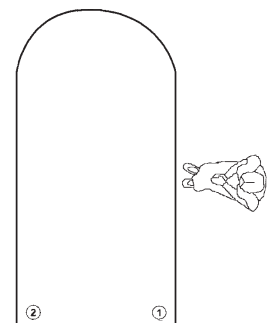

Computer Corner

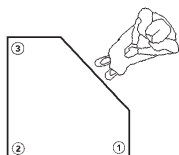

Bridges

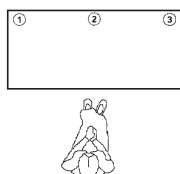

3100 Series

Functional, Contemporary Laminate Designs Offering Clean Lines with Modular Convenience.



Crescent Pull



Wire Pull



Button Pull



Tab Pull



Standard Pull



Traditional Pull



3100

| Model Number | Description | Width | Height | Depth | List |
|--------------|--------------------------|-------|--------|-------|------|
| Op-B1 | Standard Pull Black | 278mm | 18mm | 10mm | \$38 |
| Op-N1 | Standard Pull Nickel | 278mm | 18mm | 10mm | \$38 |
| Op-B2 | Tab Pull Black | 40mm | 26mm | 8mm | \$38 |
| Op-N2 | Tab Pull Nickel | 40mm | 26mm | 8mm | \$38 |
| Op-B3 | Wire Pull Black | 153mm | 30mm | 10mm | \$38 |
| Op-N3 | Wire Pull Nickel | 153mm | 30mm | 10mm | \$38 |
| Op-B4 | Button Pull Black | 31mm | 28mm | 15mm | \$38 |
| Op-N4 | Button Pull Nickel | 31mm | 28mm | 15mm | \$38 |
| Op-B5 | Crescent Pull Black | 100mm | 24mm | 22mm | \$38 |
| Op-N5 | Crescent Pull Nickel | 100mm | 24mm | 22mm | \$38 |
| Op-A6 | Traditional Pull Antique | 147mm | 48mm | 14mm | \$38 |

HARDWARE:

| | | Depth | Width | Height | List | Weight | Cube |
|---|--|-------|-------|--------|-------|--------|------|
| Standard Keyboard Tray | KBT-Standard | 20 | 22 | 2 | \$118 | 10 | 2 |
| Standard Keyboard Tray With Mouse Tray | KBT-Standard-MT | 20 | 22 | 3 | \$196 | 10 | 2 |
| Keyboard Tray With Articulating Arm and Mouse Tray | KBT-ArtArm-MT | 20 | 27 | 4 | \$356 | 10 | 2 |
| Desk Lock | Op-DESK-LOCK | | | | \$62 | | |
| Casters | OP-Casters (add 2" to height) | | | 2 | \$128 | | |
| Cartoning | Corner guards, cardboard top, & sides (Priced per box) | | | | \$74 | | |
| | Bubble Wrap | | | | \$74 | | |
| | Bubble Wrap & Palletize | | | | \$126 | | |

Sizes are nominal.

NOTES

2200 Series

Hardwood Radius Ends and Laminate Exterior Lend a Modern Feel to a Classic Design.

Laminate

Radius End

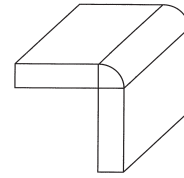

Standard Features:

- Full Suspension on all Drawers.
- Box/File Pedestals.
- Touch Latch Doors on Credenzas.
- File Drawers Supplied with Rods for Hanging Legal and Letter Files.
- Matching Vertical Grain Drawer Fronts.
- 1/2" 9 Ply UV Coating Birch Drawer Material
- 20" Depth on Credenzas, Returns, Lateral Files, and Bridges.
- One Piece Vertical Grain Modesty Panels.
- Adjustable Leveling Glides (Except Bookcases).
- Thermofused Laminate on all Tops and Sides.
- Locks Keyed Alike.

Desks - Double/Single Pedestal (DP/SP)

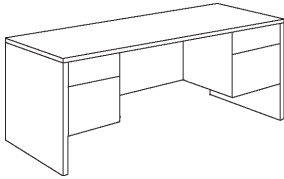

| Model Number | Depth | Width | Height | List | Weight | Cube |
|---------------------|-------|-------|--------|-------|--------|------|
| 22-DP-3060 w/1 lock | 30 | 60 | 29 | \$820 | 265 | 36 |
| 22-DP-3066 w/1 lock | 30 | 66 | 29 | \$906 | 275 | 40 |
| 22-DP-3672 w/1 lock | 36 | 72 | 29 | \$978 | 305 | 51 |
| 22-SP-2448 w/1 lock | 24 | 48 | 29 | \$606 | 135 | 24 |
| 22-SP-3048 w/1 lock | 30 | 48 | 29 | \$692 | 145 | 29 |

\$210 List to add 6" increments (\$122 List cut downs)

Credenzas (C-Open/C-Cab)

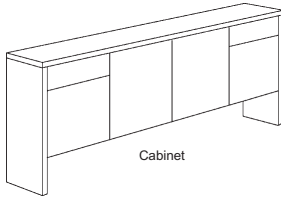

| | | | | | | |
|----------------|----|----|----|-------|-----|----|
| 22-C-2060-Cab | 20 | 60 | 29 | \$820 | 223 | 25 |
| 22-C-2060-Open | 20 | 60 | 29 | \$820 | 205 | 25 |
| 22-C-2066-Cab | 20 | 66 | 29 | \$906 | 229 | 27 |
| 22-C-2066-Open | 20 | 66 | 29 | \$906 | 211 | 27 |
| 22-C-2072-Cab | 20 | 72 | 29 | \$978 | 235 | 30 |
| 22-C-2072-Open | 20 | 72 | 29 | \$978 | 217 | 30 |

24" Credenza depth add \$210 List

\$210 List to add 6" increments (\$122 List cut downs)

Desks with Return (DR)

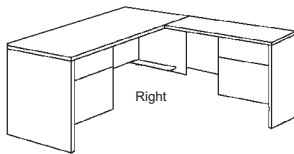

| | | | | | | |
|------------------------|----|----|----|---------|-----|----|
| 22-DR-3060-2042 | 72 | 60 | 29 | \$1,264 | 280 | 54 |
| • 22-Dsp-3060 w/1 lock | 30 | 60 | 29 | \$782 | 195 | 36 |
| • 22-Ret-2042 | 20 | 42 | 29 | \$482 | 85 | 18 |
| 22-DR-3066-2447 | 77 | 66 | 29 | \$1,438 | 335 | 63 |
| • 22-Dsp-3066 w/1 lock | 30 | 66 | 29 | \$892 | 215 | 40 |
| • 22-Ret-2447 | 24 | 47 | 29 | \$546 | 120 | 23 |
| 22-DR-3672-2047 | 83 | 72 | 29 | \$1,420 | 320 | 71 |
| • 22-Dsp-3672 w/1 lock | 36 | 72 | 29 | \$938 | 225 | 51 |
| • 22-Ret-2047 | 20 | 47 | 29 | \$482 | 95 | 20 |
| 22-DR-3672-2447 | 83 | 72 | 29 | \$1,484 | 345 | 74 |
| • 22-Dsp-3672 w/1 lock | 36 | 72 | 29 | \$938 | 225 | 51 |
| • 22-Ret-2447 | 24 | 47 | 29 | \$546 | 120 | 23 |

\$210 List to add 6" increments (\$122 List cut downs)

Computer Corner with Return (CR)

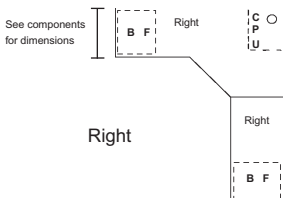

| | | | | | | |
|-----------------|----|----|----|---------|-----|----|
| 22-CR-3666-2042 | 78 | 66 | 29 | \$1,508 | 290 | 65 |
| • 22-CCCsp-3666 | 36 | 66 | 29 | \$1,026 | 205 | 47 |
| • 22-Ret-2042 | 20 | 42 | 29 | \$482 | 85 | 18 |
| 22-CR-3672-2447 | 83 | 72 | 29 | \$1,684 | 335 | 74 |
| • 22-CCDsp-3672 | 36 | 72 | 29 | \$1,138 | 215 | 51 |
| • 22-Ret-2447 | 24 | 47 | 29 | \$546 | 120 | 23 |

See components for cutdowns

Sizes are nominal.

2200 Series

Hardwood Radius Ends and Laminate Exterior Lend a Modern Feel to a Classic Design.

Computer U-Shape Desks (CU)

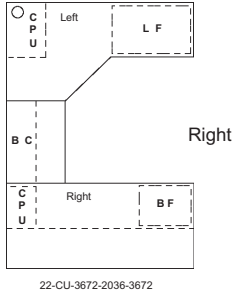

Hutches (H)

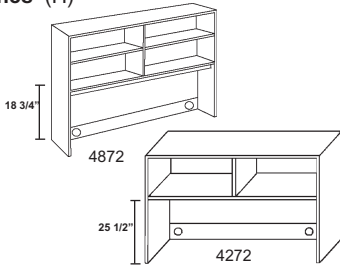

Work Tables (WT)

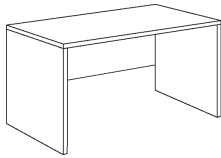

Lateral Files (LF)

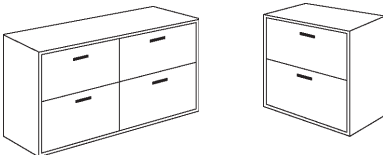

Vertical Files (VF)

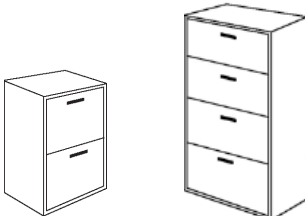

| Model Number | Depth | Width | Height | List | Weight | Cube |
|--|-------|-------|--------|---------|--------|------|
| 22-CU-3066-2036-3666 | 102 | 66 | 29 | \$2,264 | 520 | 102 |
| • 22-Dsp-3066 w/1 lock | 30 | 66 | 29 | \$892 | 215 | 40 |
| • 22-BR-2036-BC | 20 | 36 | 29 | \$346 | 100 | 15 |
| • 22-CCCsp-3666-BF | 36 | 66 | 29 | \$1,026 | 205 | 47 |
| 22-CU-3672-2036-3672 | 108 | 72 | 29 | \$2,586 | 575 | 117 |
| • 22-Dsp-3672 w/1 lock | 36 | 72 | 29 | \$938 | 225 | 51 |
| • 22-BR-2036-BC | 20 | 36 | 29 | \$346 | 100 | 15 |
| • 22-CCCsp-3672-LF w/1 lock | 36 | 72 | 29 | \$1,302 | 250 | 51 |
| 22-NCU-3672-2448-2072 | 103 | 72 | 29 | \$2,424 | 550 | 104 |
| • 22-Dsp-3672 w/1 lock | 36 | 72 | 29 | \$938 | 225 | 51 |
| • 22-BR-2448-BC | 24 | 47 | 29 | \$444 | 120 | 23 |
| • 22-Csp-2072-LF w/1 lock | 20 | 72 | 29 | \$1,042 | 205 | 30 |
| See components for cutdowns | | | | | | |
| 22-H-4857 | 14 | 57 | 48 | \$860 | 150 | 29 |
| 22-H-4863 | 14 | 63 | 48 | \$890 | 155 | 30 |
| 22-H-4869 | 14 | 69 | 48 | \$890 | 160 | 35 |
| 22-H-4257 | 14 | 57 | 43 | \$626 | 130 | 26 |
| 22-H-4263 | 14 | 63 | 43 | \$684 | 135 | 30 |
| 22-H-4269 | 14 | 69 | 43 | \$684 | 140 | 31 |
| 21-H-48-Filler (Fills space between hutches) | 1 | 4 | 48 | \$126 | 3 | 1 |
| 21-H-42-Filler | 1 | 4 | 42 | \$126 | 3 | 1 |
| OP-H-Organizer | 10 | 12 | 12 | \$168 | 4 | 1 |
| Doors not standard See options for door types | | | | | | |
| \$210 List cut downs | | | | | | |
| 22-WT-2036 | 20 | 36 | 29 | \$334 | 65 | 15 |
| 22-WT-2042 | 20 | 42 | 29 | \$408 | 85 | 18 |
| 22-WT-2048 | 20 | 48 | 29 | \$452 | 95 | 20 |
| 22-WT-2060 | 20 | 60 | 29 | \$600 | 100 | 25 |
| 22-WT-2072 | 20 | 72 | 29 | \$620 | 115 | 30 |
| 22-WT-2448 | 24 | 48 | 29 | \$452 | 110 | 24 |
| 22-WT-3048 | 30 | 48 | 29 | \$544 | 130 | 29 |
| 22-WT-3060 | 30 | 60 | 29 | \$610 | 140 | 36 |
| 22-WT-3672 | 36 | 72 | 29 | \$700 | 160 | 51 |
| \$210 List to add 6" increments (\$122 List cut downs) | | | | | | |
| 22-LF-2038-2D | 20 | 38 | 29 | \$686 | 170 | 15 |
| 22-LF-2072-4D | 20 | 72 | 29 | \$1,270 | 330 | 30 |
| Locks Standard | | | | | | |
| 22-VF-2423-2D | 24 | 23 | 29 | \$520 | 120 | 12 |
| 22-VLF-2038-4D | 20 | 38 | 54 | \$1,456 | 330 | 30 |
| Locks Standard | | | | | | |

Sizes are nominal.

2200 Series

Solid Hardwood Edges, Laminate, Available in Four Profiles, Introduce Artistic Flair to These Stylish Designs.

How to Specify Left or Right Components

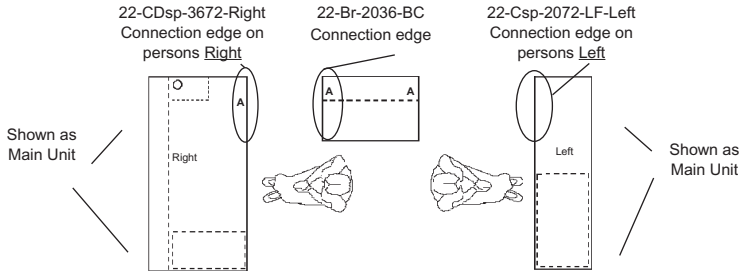

“Right” = Connects to Right side of main desk.

“Left” = Connects to Left side of main desk.

“A” = 20” Width

“B” = 24” Width

Components

Desk Tops

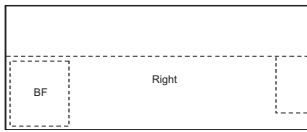

Computer Corners & Credenzas

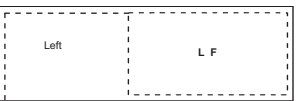
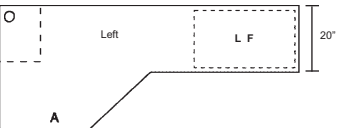
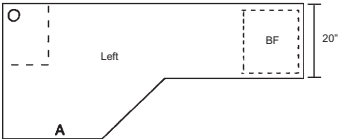
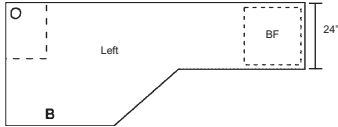

| Model Number | Depth | Width | Height | List | Weight | Cube |
|--|-------|-------|--------|---------|--------|------|
| 22-Dsp-3060 w/1 lock | 30 | 60 | 29 | \$782 | 195 | 36 |
| 22-Dsp-3066 w/1 lock | 30 | 66 | 29 | \$892 | 215 | 40 |
| 22-Dsp-3672 w/1 lock | 36 | 72 | 29 | \$938 | 225 | 51 |
| \$210 List to add 6" increments (\$122 List cut downs) | | | | | | |
| 22-CCDsp-3672 | 36 | 72 | 29 | \$1,138 | 215 | 51 |
| 22-CCCsp-3666 | 36 | 66 | 29 | \$1,026 | 205 | 47 |
| 22-CCCsp-3672-LF w/1 lock w/handles (B1) | 36 | 72 | 29 | \$1,302 | 250 | 51 |
| \$298 List to add 6" increments (\$210 List cut downs) | | | | | | |
| 22-Csp-2060 | 20 | 60 | 29 | \$782 | 155 | 25 |
| 22-Csp-2072 | 20 | 72 | 29 | \$938 | 166 | 30 |
| 22-Csp-2060-LF w/1 lock w/handles (B1) | 20 | 60 | 29 | \$1,042 | 195 | 25 |
| 22-Csp-2072-LF w/1 lock w/handles (B1) | 20 | 72 | 29 | \$1,042 | 205 | 30 |
| \$210 List to add 6" increments (\$122 List cut downs) | | | | | | |



Sizes are nominal.

2200 Series

Solid Hardwood Edges, Laminate, Available in Four Profiles, Introduce Artistic Flair to These Stylish Designs.

Returns-20" W/BF Pedestals

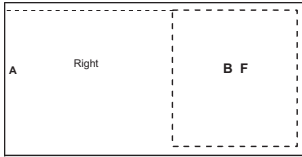

Returns-24" W/BF Pedestals

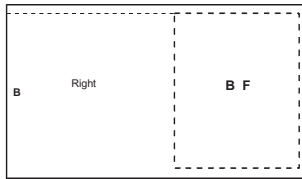

Rectangular Bridges W/Bookcase

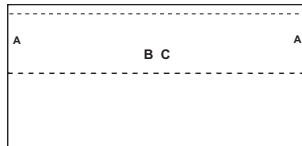

| | Model Number | Depth | Width | Height | List | Weight | Cube |
|--|--|-------|-------|--------|-------|--------|------|
| | 22-Ret-2042 | 20 | 42 | 29 | \$482 | 85 | 18 |
| | 22-Ret-2047 | 20 | 47 | 29 | \$482 | 95 | 20 |
| | | | | | | | |
| | | | | | | | |
| | | | | | | | |
| | | | | | | | |
| | \$210 List to add 6" increments (\$122 List cut downs) | | | | | | |
| | 22-Ret-2447 | 24 | 47 | 29 | \$546 | 120 | 23 |
| | | | | | | | |
| | | | | | | | |
| | | | | | | | |
| | | | | | | | |
| | \$210 List to add 6" increments (\$122 List cut downs) | | | | | | |
| | 22-BR-2036-BC | 20 | 36 | 29 | \$346 | 100 | 15 |
| | 22-BR-2447-BC | 24 | 47 | 29 | \$444 | 120 | 23 |
| | | | | | | | |
| | | | | | | | |
| | | | | | | | |
| | | | | | | | |
| | | | | | | | |
| | | | | | | | |
| | | | | | | | |
| | | | | | | | |
| | | | | | | | |
| | | | | | | | |
| | | | | | | | |
| | | | | | | | |
| | | | | | | | |
| | | | | | | | |
| | | | | | | | |
| | | | | | | | |
| | | | | | | | |
| | | | | | | | |
| | | | | | | | |
| | | | | | | | |
| | | | | | | | |
| | | | | | | | |
| | | | | | | | |
| | | | | | | | |
| | | | | | | | |
| | | | | | | | |
| | | | | | | | |
| | | | | | | | |
| | | | | | | | |
| | | | | | | | |
| | | | | | | | |
| | | | | | | | |
| | | | | | | | |
| | | | | | | | |
| | | | | | | | |
| | | | | | | | |

Sizes are nominal.

2200 Series

Solid Hardwood Edges, Laminate, Available in Four Profiles, Introduce Artistic Flair to These Stylish Designs.

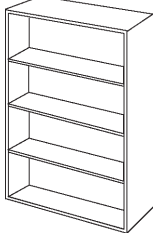
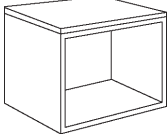
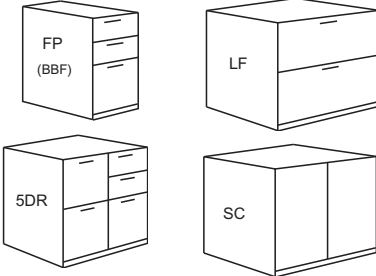
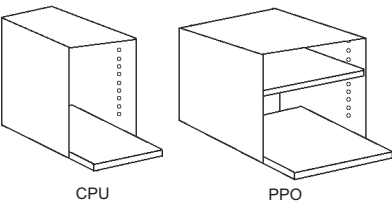
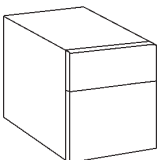
| | Model Number | Depth | Width | Height | List | Weight | Cube | |
|---|--|------------|-------|--------|-----------------|-----------|------|---|
| Bookcases (BC)  | 22-BC-2936-1 | 12 | 36 | 29 | \$346 | 70 | 10 | |
| | 22-BC-4834-2L For 2-D Lateral No Bottom | 14 | 34 | 48 | \$514 | 75 | 15 | |
| | 22-BC-4836-2 | 12 | 36 | 48 | \$444 | 85 | 16 | |
| | 22-BC-6036-3 | 12 | 36 | 60 | \$526 | 100 | 20 | |
| | 22-BC-7236-4 | 12 | 36 | 72 | \$548 | 115 | 23 | |
| | 22-BC-8436-5 | 12 | 36 | 84 | \$686 | 140 | 27 | |
| | 22-BC-3612-BKSLF Bookcase Shelf | 12 | 36 | 1.1 | \$62 | 6 | 1 | |
| | 22-BC-L-Cab 29" Lower Cabinet (72" & 84" only) | | | | \$296 | 15 | | |
| | \$210 List cut downs | | | | | | | |
| | Occasional Tables (OT)  | 22-OT-2020 | 20 | 20 | 20 | \$276 | 40 | 7 |
| 22-OT-2048 | | 20 | 48 | 20 | \$388 | 65 | 15 | |
| \$210 List to add 6" increments (\$122 List cut downs) | | | | | | | | |
| Stand Alone Pedestals (PED)  | 21-PED-2017-FP-SA Specify - Box/Box/File or File/File | 19 | 17 | 27 | \$526 | 45 | 7 | |
| | 21-PED-2036-LF-SA w/handles (B1) | 19 | 36 | 27 | \$588 | 65 | 14 | |
| | 21-PED-2033-5DR-SA w/handles (B1) | 19 | 33 | 27 | \$880 | 70 | 13 | |
| | 21-PED-2036-SC-SA | 19 | 36 | 27 | \$588 | 65 | 14 | |
| | Note - Peds have unfinished backs See hardware for casters Adding casters will make unit 29 high | | | | | | | |
| Built in Printer and CPU Pullouts (PPO, CPU)  | 21-PPO-20 | 19 | 22 | 20 | \$284 | 15 | | |
| | 21-CPU-PO-20 20" depth units only | 19 | 12 | 20 | \$252 | 10 | | |
| | 21-PPO-24 | 23 | 22 | 24 | \$284 | 17 | | |
| | 21-CPU-PO-24 24", 30", 36" depth units only | 23 | 12 | 24 | \$252 | 12 | | |
| Must be added to no ped, full ped, or lat file units only | | | | | | | | |
| Built in Pedestals (PED)  | 21-PED-2017-BF-BI add peds remove peds | 19 | 17 | 18 | \$240 -\$176 | 30 -30 | | |
| | 21-PED-2036-LF-BI add peds | 19 | 36 | 27 | \$588 | 65 | | |
| | 21-PED-2032-5DR-BI add peds | 19 | 33 | 24 | \$824 | 70 | | |
| | Space Limitations Apply See Options for full ped upcharge | | | | | | | |

2200

Sizes are nominal.

2200 Series

Hardwood Radius Ends and Laminate Exterior Lend a Modern Feel to a Classic Design.

| | Model Number | Depth | Width | Height | List | Weight | Cube |
|--|---|-------|-------|--------|-------|--------|------|
| OPTIONS: | | | | | | | |
| Center Drawer Large | Op-LAM-CD-Large | 20 | 26 | 3 | \$110 | 4 | 2 |
| Center Drawer Small | Op-LAM-CD-Small | 20 | 20 | 3 | \$110 | 4 | 2 |
| Full Pedestal With Lock File File Configuration Or Box Box File Configuration (Includes Full Modesty) | FULL PED | | | | \$212 | 15 | |
| Hutch Doors | 21-H-Half Laminate Doors | 13 | 15 | 2 | \$210 | 10 | |
| | 21-H-Full Glass Doors | 13 | 25 | 2 | \$856 | 20 | |
| | 21-CH-Full Glass Doors | 13 | 25 | 2 | \$856 | 20 | |
| | 21-H-Upper Half Glass Doors | 13 | 15 | 2 | \$708 | 10 | |
| | 21-CH-Upper Half Glass Doors | 13 | 15 | 2 | \$708 | 10 | |
| Printer and CPU Doors | 21-CPU-Door | 1 | 12 | 24 | \$78 | 3 | |
| | 21-PPO-Door | 1 | 21 | 24 | \$78 | 4 | |
| Full Modesty Panel | FULL MOD | | | | \$78 | 10 | |
| COLORS: | | | | | | | |
| Cherry | LCH | | | | | | |
| Dark Cherry | LDC | | | | | | |
| Mahogany | LMA | | | | | | |
| Medium Oak | LMO | | | | | | |
| Walnut | LWA | | | | 5% | | |
| Maple | LMP | | | | | | |
| Folk Stone | LFS (Base only) | | | | | | |
| Slate Grey | LSL (Base only) | | | | | | |
| Black | LBL (Base only) | | | | | | |
| Mixed Colors (Additional Up Charge) | | | | | 5% | | |
| High Pressure Tops | Includes choice from most colors by: Formica, Nevamar, Pionite, & Wilsonart | | | | 20% | | |
| Touch-up Crayons (in all colors) | Specify Color | | | | \$16 | | |
| Touch-up Markers (in all colors) | Specify Color | | | | \$22 | | |

Sizes are nominal.

2200 Series

Hardwood Radius Ends and Laminate Exterior Lend a Modern Feel to a Classic Design.



| | Model Number | Description | List |
|--|------------------------|--|---------------------------------|
| Grommet | Op-Grom | (Installed) Hardware, Grommet, 60mm Cable, Black | \$52 |
| | Powered Grommet | Op-Pwr-Grom | Retractable Power Grommet black |
| Power Grommets Holds 1 or 2 Data Modules Only. | Op-IL-RJ11-Cat. 3 | In-line data module, RJ 11Cat. 3 black | \$48 |
| | Op-IL-RJ45-Cat. 3 | In-line data module, RJ 45 Cat. 3 black | \$48 |
| | Op-HW-RJ11-Cat. 3 | Hard wire data module, RJ 11 Cat. 3 black | \$48 |
| | Op-HW-RJ45-Cat. 3 | Hard wire data module, RJ 45 Cat. 3 black | \$48 |
| | Op-HW-RJ45-Cat. 5 | Hard wire data module, RJ 45 Cat. 5 black | \$48 |
| | Op-HW-RJ45-Cat. 6 | Hard wire data module, RJ 45 Cat. 6 orange | \$82 |

Grommet Placement Guide

When choosing an optional grommet, please use the drawings below to determine where you would like the grommet placed on the worksurface. For grommet placement in the modesty panels, place an "M" ahead of the number. Grommets through modesty panels are positioned at the highest possible point on the modesty panel.

For example: To have the grommet placed in the center of the modesty panel of a return, indicate "M1" on the order line for that item.

Please Note: Grommets cannot go through pedestals on 20" depth units.

Single Pedestal Right

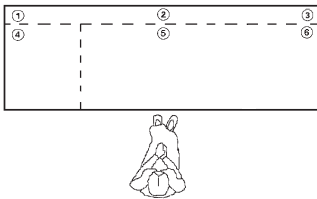

Single Pedestal Left

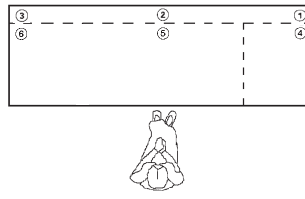

Double Pedestal

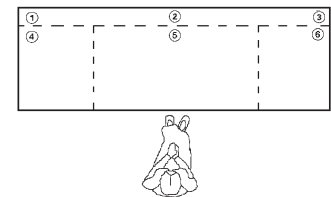

Computer Corner Credenzas

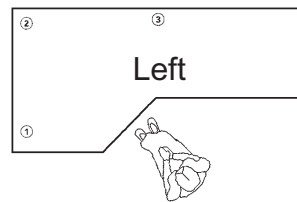
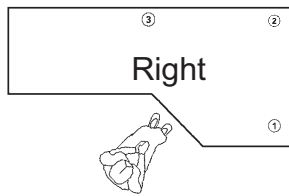

Credenzas

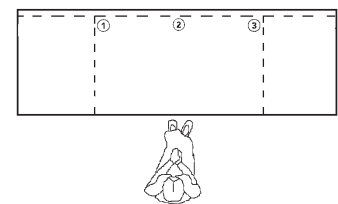

Return Right

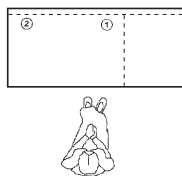

Return Left

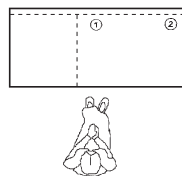

Conference Tables

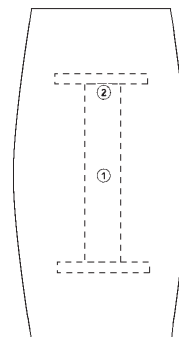

Bullet/P-tops

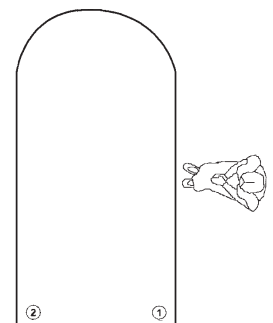

Computer Corner

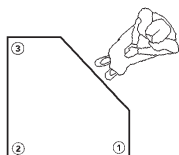

Bridges

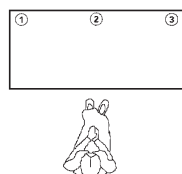

2200

2200 Series

Hardwood Radius Ends and Laminate Exterior Lend a Modern Feel to a Classic Design.



Crescent Pull



Wire Pull



Button Pull



Tab Pull



Standard Pull



Traditional Pull



| Model Number | Description | Width | Height | Depth | List |
|--------------|--------------------------|-------|--------|-------|------|
| Op-B1 | Standard Pull Black | 278mm | 18mm | 10mm | \$38 |
| Op-N1 | Standard Pull Nickel | 278mm | 18mm | 10mm | \$38 |
| Op-B2 | Tab Pull Black | 40mm | 26mm | 8mm | \$38 |
| Op-N2 | Tab Pull Nickel | 40mm | 26mm | 8mm | \$38 |
| Op-B3 | Wire Pull Black | 153mm | 30mm | 10mm | \$38 |
| Op-N3 | Wire Pull Nickel | 153mm | 30mm | 10mm | \$38 |
| Op-B4 | Button Pull Black | 31mm | 28mm | 15mm | \$38 |
| Op-N4 | Button Pull Nickel | 31mm | 28mm | 15mm | \$38 |
| Op-B5 | Crescent Pull Black | 100mm | 24mm | 22mm | \$38 |
| Op-N5 | Crescent Pull Nickel | 100mm | 24mm | 22mm | \$38 |
| Op-A6 | Traditional Pull Antique | 147mm | 48mm | 14mm | \$38 |

HARDWARE:

| | | Depth | Width | Height | List | Weight | Cube |
|---|--|-------|-------|--------|-------|--------|------|
| Standard Keyboard Tray | KBT-Standard | 20 | 22 | 2 | \$118 | 10 | 2 |
| Standard Keyboard Tray With Mouse Tray | KBT-Standard-MT | 20 | 22 | 3 | \$196 | 10 | 2 |
| Keyboard Tray With Articulating Arm and Mouse Tray | KBT-ArtArm-MT | 20 | 27 | 4 | \$356 | 10 | 2 |
| Desk Lock | Op-DESK-LOCK | | | | \$62 | | |
| Casters | OP-Casters (add 2" to height) | | | 2 | \$128 | | |
| Cartoning | Corner guards, cardboard top, & sides (Priced per box) | | | | \$74 | | |
| | Bubble Wrap | | | | \$74 | | |
| | Bubble Wrap & Palletize | | | | \$126 | | |

Sizes are nominal.

2300 Series

Solid Hardwood Edges, Laminate, Available in Four Profiles, Introduce Artistic Flair to These Stylish Designs.

Standard Features:

- Full Suspension on all Drawers.
- Box/File Pedestals.
- 1/2" 9 Ply UV Coated Birch Drawer Material
- Touch Latch Doors on Credenzas.
- File Drawers Supplied with Rods for Hanging Legal and Letter Files.
- Solid Hardwood 4 Way Edge on Top Available in Four Profiles.
- Matching Vertical Grain Drawer Fronts.
- 20" Depth on Credenzas, Returns, Lateral Files, and Bridges.
- One Piece Vertical Grain Modesty Panels.
- Adjustable Leveling Glides (except Bookcases).
- Thermofused Laminate on all Tops and Sides.
- Locks Keyed Alike.

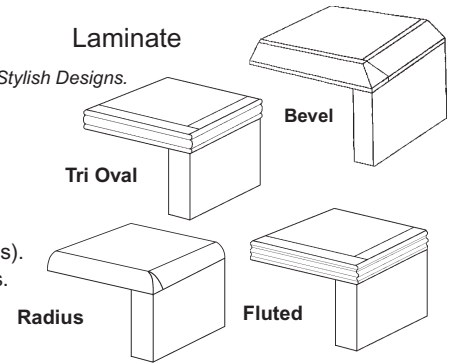

Desks - Double Pedestal/Single Pedestal/ Fan Top Desk (DP/SP/FDP)

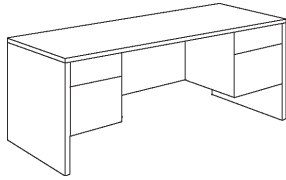

| Model Number | Depth | Width | Height | List | Weight | Cube |
|--|-------|-------|--------|---------|--------|------|
| 23-DP-3060 w/1 lock | 30 | 60 | 29 | \$1,092 | 285 | 36 |
| 23-DP-3066 w/1 lock | 30 | 66 | 29 | \$1,186 | 290 | 40 |
| 23-DP-3672 w/1 lock | 36 | 72 | 29 | \$1,224 | 310 | 51 |
| 23-SP-2448 w/1 lock | 24 | 48 | 29 | \$858 | 135 | 24 |
| 23-SP-3048 w/1 lock | 30 | 48 | 29 | \$886 | 145 | 29 |
| \$210 List to add 6" increments (\$122 List cut downs) | | | | | | |
| 23-FDP-3066 w/1 lock | 36 | 66 | 29 | \$1,680 | 320 | 51 |
| 23-FDP-3672 w/1 lock | 42 | 72 | 29 | \$1,726 | 345 | 59 |
| \$298 List to add 6" increments (\$210 List cut downs) | | | | | | |

Credenzas (C-Open/C-Cab)

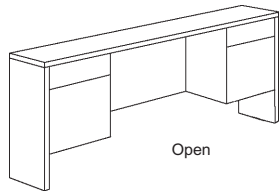

| | | | | | | |
|--|----|----|----|---------|-----|----|
| 23-C-2060-Cab | 20 | 60 | 29 | \$1,092 | 223 | 25 |
| 23-C-2060-Open | 20 | 60 | 29 | \$1,092 | 205 | 25 |
| 23-C-2066-Cab | 20 | 66 | 29 | \$1,186 | 229 | 27 |
| 23-C-2066-Open | 20 | 66 | 29 | \$1,186 | 211 | 27 |
| 23-C-2072-Cab | 20 | 72 | 29 | \$1,224 | 235 | 30 |
| 23-C-2072-Open | 20 | 72 | 29 | \$1,224 | 217 | 30 |
| 24" Credenza depth add \$210 List | | | | | | |
| \$210 List to add 6" increments (\$122 List cut downs) | | | | | | |

Desks with Return (DR)

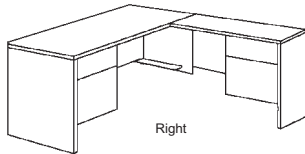

| | | | | | | |
|------------------------|----|----|----|---------|-----|----|
| 23-DR-3060-2042 | 72 | 60 | 29 | \$1,524 | 280 | 54 |
| • 23-Dsp-3060 w/1 lock | 30 | 60 | 29 | \$948 | 195 | 36 |
| • 23-Ret-2042 | 20 | 42 | 29 | \$576 | 85 | 18 |
| 23-DR-3066-2447 | 77 | 66 | 29 | \$1,750 | 335 | 63 |
| • 23-Dsp-3066 w/1 lock | 30 | 66 | 29 | \$1,060 | 215 | 40 |
| • 23-Ret-2447 | 24 | 47 | 29 | \$690 | 120 | 23 |

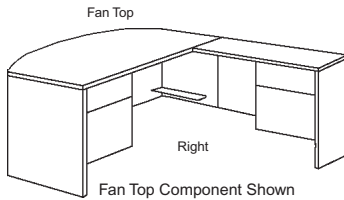

| | | | | | | |
|------------------------|----|----|----|---------|-----|----|
| 23-DR-3672-2047 | 83 | 72 | 29 | \$1,784 | 320 | 71 |
| • 23-Dsp-3672 w/1 lock | 36 | 72 | 29 | \$1,138 | 225 | 51 |
| • 23-Ret-2047 | 20 | 47 | 29 | \$646 | 95 | 20 |
| 23-DR-3672-2447 | 83 | 72 | 29 | \$1,828 | 345 | 74 |
| • 23-Dsp-3672 w/1 lock | 36 | 72 | 29 | \$1,138 | 225 | 51 |
| • 23-Ret-2447 | 24 | 47 | 29 | \$690 | 120 | 23 |

Reception Unit (Recep)

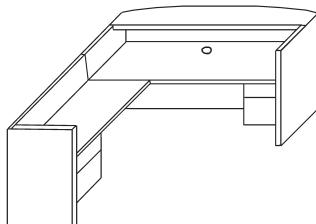

| | | | | | | |
|--|----|----|----|---------|-----|----|
| Fan & P-Top Available (See Components) | | | | | | |
| \$210 List to add 6" increments (\$122 List cut downs) | | | | | | |
| 23-Recep-3072-2447 | 77 | 72 | 43 | \$3,284 | 530 | 96 |
| • 23-Recep-3072 w/1 lock | 30 | 72 | 43 | \$2,298 | 380 | 62 |
| • 23-Recep-Ret-2447 | 24 | 47 | 43 | \$986 | 150 | 34 |
| \$350 List to add 6" increments (\$210 List cut downs) | | | | | | |

Sizes are nominal.

2300 Series

Solid Hardwood Edges, Laminate, Available in Four Profiles, Introduce Artistic Flair to These Stylish Designs.

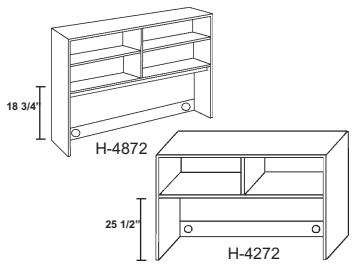
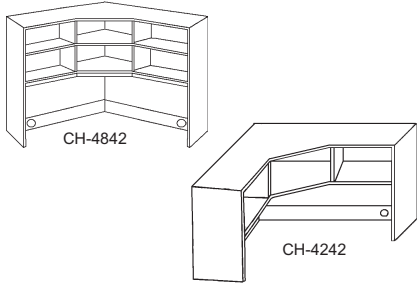
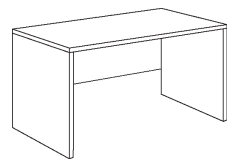
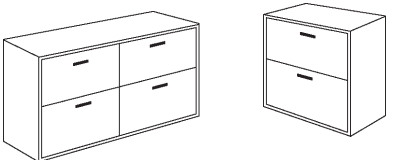
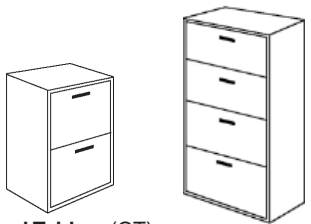
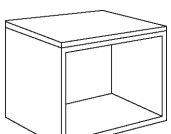
| | Model Number | Depth | Width | Height | List | Weight | Cube | |
|---|---|------------------------------|-------|--------|---------|---------|------|----|
| Hutches (H,CH,H-Filler,H-Organizer)  | 23-H-4845 | 14 | 45 | 48 | \$860 | 140 | 24 | |
| | 23-H-4857 | 14 | 57 | 48 | \$860 | 150 | 28 | |
| | 23-H-4863 | 14 | 63 | 48 | \$900 | 155 | 30 | |
| | 23-H-4869 | 14 | 69 | 48 | \$900 | 160 | 33 | |
| | 23-H-4245 | 14 | 45 | 43 | \$646 | 120 | 20 | |
| | 23-H-4257 | 14 | 57 | 43 | \$646 | 130 | 25 | |
| | 23-H-4263 | 14 | 63 | 43 | \$702 | 135 | 27 | |
| | 23-H-4269 | 14 | 69 | 43 | \$702 | 140 | 30 | |
| | Corner Hutches (CH)  | 23-CH-4836 | 36 | 36 | 48 | \$1,134 | 150 | 42 |
| | | 23-CH-4842 | 42 | 42 | 48 | \$1,206 | 160 | 56 |
| 23-CH-4236 | | 36 | 36 | 43 | \$890 | 130 | 37 | |
| 23-CH-4242 | | 42 | 42 | 43 | \$940 | 140 | 50 | |
| 21-H-48-Filler (Fills space between hutches) | | 1 | 4 | 48 | \$126 | 3 | 1 | |
| 21-H-42-Filler | | 1 | 4 | 42 | \$126 | 3 | 1 | |
| OP-H-Organizer | | 10 | 12 | 12 | \$168 | 4 | 1 | |
| Doors not standard See options for door types | | | | | | | | |
| \$210 List cut downs (not available on corner hutch) | | | | | | | | |
| Work Tables (WT)  | | 23-WT-2036 | 20 | 36 | 29 | \$472 | 65 | 15 |
| | 23-WT-2042 | 20 | 42 | 29 | \$588 | 85 | 18 | |
| | 23-WT-2048 | 20 | 48 | 29 | \$612 | 95 | 20 | |
| | 23-WT-2060 | 20 | 60 | 29 | \$646 | 100 | 25 | |
| | 23-WT-2072 | 20 | 72 | 29 | \$790 | 115 | 30 | |
| | 23-WT-2448 | 24 | 48 | 29 | \$612 | 110 | 24 | |
| | 23-WT-3048 | 30 | 48 | 29 | \$646 | 130 | 29 | |
| | 23-WT-3060 | 30 | 60 | 29 | \$754 | 140 | 36 | |
| | 23-WT-3672 | 36 | 72 | 29 | \$838 | 160 | 51 | |
| | \$210 List to add 6" increments (\$122 List cut downs) | | | | | | | |
| | Lateral Files (LF)  | 23-LF-2038-2D w/handles (B1) | 20 | 38 | 29 | \$774 | 170 | 15 |
| | | 23-LF-2072-4D w/handles (B1) | 20 | 72 | 29 | \$1,440 | 330 | 30 |
| | | Locks Standard | | | | | | |
| | | | | | | | | |
| Vertical Files (VF)  | 23-VF-2423-2D w/handles (B1) | 24 | 23 | 29 | \$602 | 120 | 12 | |
| | 23-VLF-2038-4D w/handles (B1) | 20 | 38 | 54 | \$1,624 | 330 | 30 | |
| | Locks Standard | | | | | | | |
| | | | | | | | | |
| Occasional Tables (OT)  | 23-OT-2020 | 20 | 20 | 20 | \$314 | 40 | 7 | |
| | 23-OT-2048 | 20 | 48 | 20 | \$426 | 65 | 15 | |
| | \$210 List to add 6" increments (\$122 List cut downs) | | | | | | | |

Sizes are nominal.

2300 Series

Solid Hardwood Edges, Laminate, Available in Four Profiles, Introduce Artistic Flair to These Stylish Designs.

Bookcases (BC)

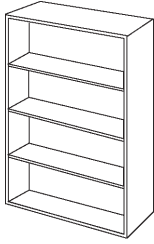

Corner Bookcases/Corner Bookcase Hutch (CBC / CBCH)

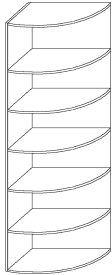
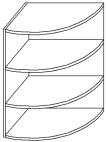

Storage Cabinets (SC)

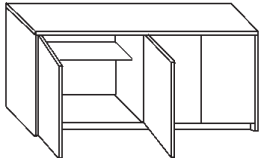
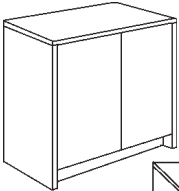

Storage - Vertical / Personal / Lateral File (VS/PS/LFS)

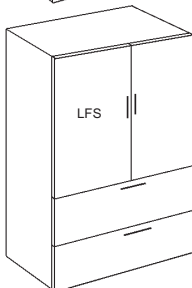
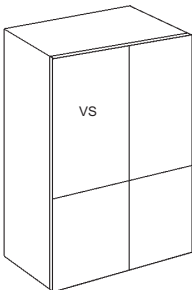
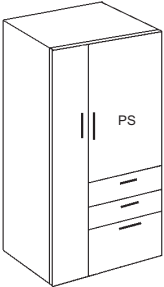

| Model Number | Depth | Width | Height | List | Weight | Cube |
|--|-------|-------|--------|---------|--------|------|
| 23-BC-2936-1 | 12 | 36 | 29 | \$372 | 70 | 10 |
| 23-BC-4834-2L For 2-D Lateral No Bottom | 14 | 34 | 48 | \$556 | 75 | 15 |
| 23-BC-4836-2 | 12 | 36 | 48 | \$502 | 85 | 16 |
| 23-BC-6036-3 | 12 | 36 | 60 | \$584 | 100 | 20 |
| 23-BC-7236-4 | 12 | 36 | 72 | \$608 | 115 | 23 |
| 23-BC-8436-5 | 12 | 36 | 84 | \$744 | 140 | 27 |
| 23-BC-3612-BKSLF Bookcase Shelf | 12 | 36 | 1.1 | \$62 | 6 | 1 |
| 23-BC-L-Cab 29" Lower Cabinet (72" & 84" only) | | | | \$296 | 15 | |
| \$210 List cut downs | | | | | | |
| 23-CBC-2029-1 | 20 | 20 | 29 | \$546 | 70 | 9 |
| 23-CBC-2072-4 | 20 | 20 | 72 | \$1,012 | 115 | 21 |
| 23-CBCH-1448 | 14 | 14 | 48 | \$656 | 70 | 8 |
| 23-CBCH-1442 | 14 | 14 | 43 | \$656 | 65 | 7 |
| 23-SC-2019 | 20 | 19 | 29 | \$602 | 110 | 8 |
| 23-SC-2032 | 20 | 32 | 29 | \$774 | 120 | 13 |
| 23-SC-2038 | 20 | 38 | 29 | \$774 | 130 | 15 |
| 23-SC-2060 | 20 | 60 | 29 | \$1,368 | 155 | 25 |
| 23-SC-2072 | 20 | 72 | 29 | \$1,464 | 165 | 30 |
| 23-VS-3872 Door Locks Optional | 20 | 38 | 72 | \$1,426 | 235 | 38 |
| 23-PS-3072 Door Locks Optional (BBF lock not available) Specify right or left (right shown) w/handles (B1) | 20 | 30 | 72 | \$2,182 | 225 | 30 |
| 23-LFS-3872 W/1 lock on LAT Door Locks Optional w/handles (B1) | 20 | 38 | 72 | \$1,942 | 250 | 38 |

Sizes are nominal.

2300 Series

Solid Hardwood Edges, Laminate, Available in Four Profiles, Introduce Artistic Flair to These Stylish Designs.

Computer U-Shape Desks (CU)

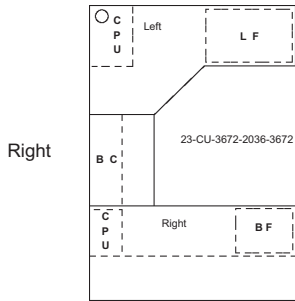

U-Shape Desks (NCU)

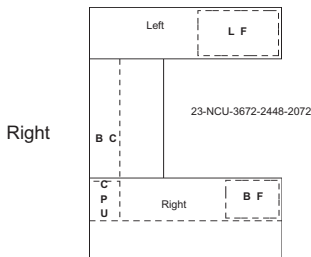

Bullet Computer U-Shape Desks (BCU)

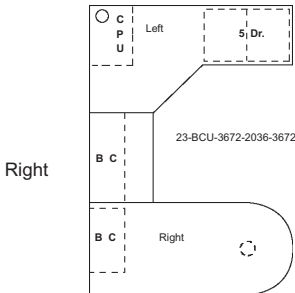

Bullet U-Shape Desks (BNCU)

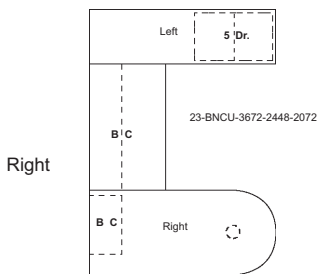

Computer Corner with Return (CR)

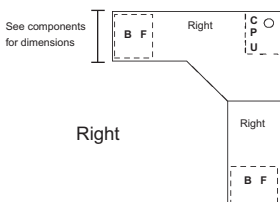

| Model Number | Depth | Width | Height | List | Weight | Cube |
|--|-------|-------|--------|---------|--------|------|
| 23-CU-3066-2036-3666 | 102 | 66 | 29 | \$2,898 | 520 | 102 |
| • 23-Dsp-3066 w/1 lock | 30 | 66 | 29 | \$1,060 | 215 | 40 |
| • 23-BR-2036-BC | 20 | 36 | 29 | \$614 | 100 | 15 |
| • 23-CCCsp-3666-BF | 36 | 66 | 29 | \$1,224 | 205 | 47 |
| 23-CU-3672-2036-3672 | 108 | 72 | 29 | \$3,348 | 575 | 117 |
| • 23-Dsp-3672 w/1 lock | 36 | 72 | 29 | \$1,138 | 225 | 51 |
| • 23-BR-2036-BC | 20 | 36 | 29 | \$614 | 100 | 15 |
| • 23-CCCsp-3672-LF w/1 lock | 36 | 72 | 29 | \$1,596 | 250 | 51 |
| w/handles (B1) | | | | | | |
| See Components for cut downs | | | | | | |
| 23-NCU-3672-2448-2072 | 103 | 72 | 29 | \$3,228 | 550 | 104 |
| • 23-Dsp-3672 w/1 lock | 36 | 72 | 29 | \$1,138 | 225 | 51 |
| • 23-BR-2447-BC | 24 | 47 | 29 | \$686 | 120 | 23 |
| • 23-Csp-2072-LF w/1 lock | 20 | 72 | 29 | \$1,404 | 205 | 30 |
| w/handles (B1) | | | | | | |
| See Components for cut downs | | | | | | |
| 23-BCU-3672-2036-3672 | 108 | 72 | 29 | \$3,724 | 490 | 117 |
| • 23-B-3672 | 36 | 72 | 29 | \$1,442 | 140 | 51 |
| • 23-BR-2036-BC | 20 | 36 | 29 | \$614 | 100 | 15 |
| • 23-CCCsp-3672-5Dr | 36 | 72 | 29 | \$1,668 | 250 | 51 |
| w/handles (B1) | | | | | | |
| Cylinder MOD Optional | | | | | | |
| 23-BCU-3684-2036-3672 | 108 | 84 | 29 | \$3,828 | 505 | 125 |
| • 23-B-3684 | 36 | 84 | 29 | \$1,546 | 155 | 59 |
| • 23-BR-2036-BC | 20 | 36 | 29 | \$614 | 100 | 15 |
| • 23-CCCsp-3672-5Dr | 36 | 72 | 29 | \$1,668 | 250 | 51 |
| w/handles (B1) | | | | | | |
| Cylinder MOD Optional | | | | | | |
| See Components for cut downs | | | | | | |
| 23-BNCU-3672-2448-2072 | 103 | 72 | 29 | \$3,580 | 465 | 104 |
| • 23-B-3672 | 36 | 72 | 29 | \$1,442 | 140 | 51 |
| • 23-BR-2447-BC | 24 | 47 | 29 | \$686 | 120 | 23 |
| • 23-Csp-2072-5DR w/handles (B1) | 20 | 72 | 29 | \$1,452 | 205 | 30 |
| Cylinder MOD Optional | | | | | | |
| Fan & P-Top Available (See Components) | | | | | | |
| 23-CR-3666-2042 | 78 | 66 | 29 | \$1,800 | 290 | 65 |
| • 23-CCCsp-3666 | 36 | 66 | 29 | \$1,224 | 205 | 47 |
| • 23-Ret-2042 | 20 | 42 | 29 | \$576 | 85 | 18 |
| 23-CR-3672-2447 | 83 | 72 | 29 | \$1,914 | 335 | 74 |
| • 23-CCDsp-3672 | 36 | 72 | 29 | \$1,224 | 215 | 51 |
| • 23-Ret-2447 | 24 | 47 | 29 | \$690 | 120 | 23 |
| See Components for cut downs | | | | | | |

Sizes are nominal.

2300 Series

Solid Hardwood Edges, Laminate, Available in Four Profiles, Introduce Artistic Flair to These Stylish Designs.

How to Specify Left or Right Components

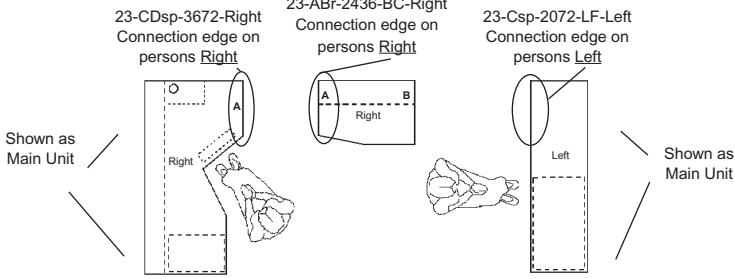

“Right” = Connects to Right side of main desk.

“Left” = Connects to Left side of main desk.

“A” = 20” Width

“B” = 24” Width

Components

Desk Tops

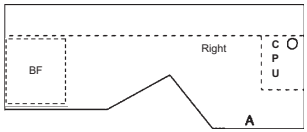
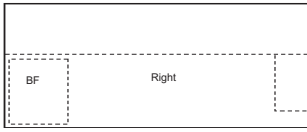

Fan Tops

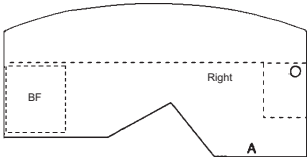
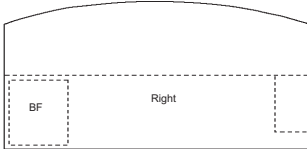

Bullet Tops

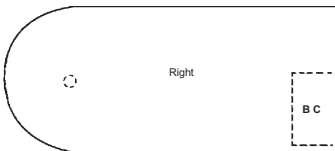

Computer Bullet Tops

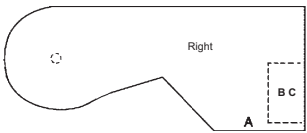

P-Tops

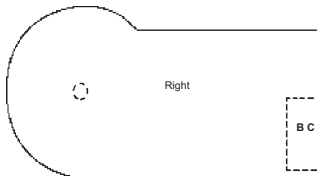

| Model Number | Depth | Width | Height | List | Weight | Cube |
|--|-------|-------|--------|---------|--------|------|
| 23-Dsp-3060 w/1 lock | 30 | 60 | 29 | \$948 | 195 | 36 |
| 23-Dsp-3066 w/1 lock | 30 | 66 | 29 | \$1,060 | 215 | 40 |
| 23-Dsp-3672 w/1 lock | 36 | 72 | 29 | \$1,138 | 225 | 51 |
| \$210 List to add 6" increments (\$122 List cut downs) | | | | | | |
| 23-CDsp-3672 w/1 lock | 36 | 72 | 29 | \$1,580 | 215 | 51 |
| \$298 List to add 6" increments (\$210 List cut downs) | | | | | | |
| 23-FDsp-3066 w/1 lock | 36 | 66 | 29 | \$1,560 | 240 | 51 |
| 23-FDsp-3672 w/1 lock | 42 | 72 | 29 | \$1,640 | 255 | 59 |
| \$298 List to add 6" increments (\$210 List cut downs) | | | | | | |
| 23-FCDsp-3672 w/1 lock | 42 | 72 | 29 | \$1,824 | 250 | 59 |
| \$298 List to add 6" increments (\$210 List cut downs) | | | | | | |
| 23-B-3672 | 36 | 72 | 29 | \$1,442 | 140 | 51 |
| 23-B-3684 | 36 | 84 | 29 | \$1,546 | 155 | 59 |
| Cylinder MOD Optional | | | | | | |
| \$298 List to add 6" increments (\$210 List cut downs) | | | | | | |
| 23-CB-3672 | 36 | 72 | 29 | \$1,718 | 135 | 51 |
| 23-CB-3684 | 36 | 84 | 29 | \$1,822 | 145 | 59 |
| Cylinder MOD Optional | | | | | | |
| \$298 List to add 6" increments (\$210 List cut downs) | | | | | | |
| 23-P-3672 | 42 | 72 | 29 | \$1,684 | 180 | 59 |
| Cylinder MOD Optional | | | | | | |
| \$298 List to add 6" increments (\$210 List cut downs) | | | | | | |

Sizes are nominal.

2300 Series

Solid Hardwood Edges, Laminate, Available in Four Profiles, Introduce Artistic Flair to These Stylish Designs.

Computer P-Tops

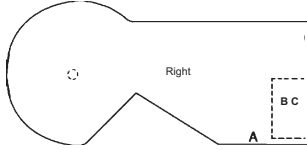

Computer Corners & Credenzas

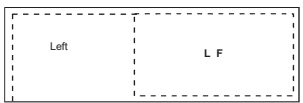
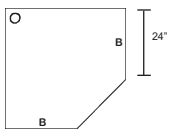
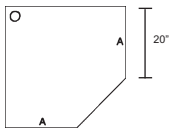
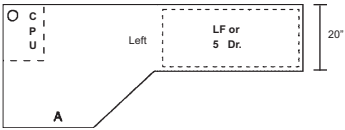
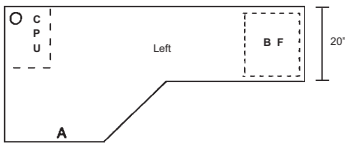
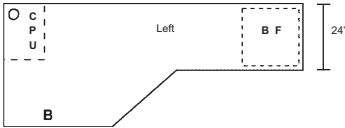

| Model Number | Depth | Width | Height | List | Weight | Cube |
|--|-------|-------|--------|---------|--------|------|
| 23-CP-3672 | 48 | 72 | 29 | \$1,870 | 160 | 67 |
| Cylinder MOD Optional | | | | | | |
| 23-CCDsp-3672 | 36 | 72 | 29 | \$1,224 | 215 | 51 |
| 23-CCCsp-3666 | 36 | 66 | 29 | \$1,224 | 205 | 47 |
| 23-CCCsp-3672 | 36 | 72 | 29 | \$1,224 | 215 | 51 |
| 23-CCCsp-3672-LF w/1 lock w/handles (B1) | 36 | 72 | 29 | \$1,596 | 250 | 51 |
| 23-CCCsp-3672-5DR w/handles (B1) | 36 | 72 | 29 | \$1,668 | 250 | 51 |
| \$210 List to add 6" increments (\$176 List cut downs) | | | | | | |
| 23-CC-3636-20 | 36 | 36 | 29 | \$808 | 135 | 26 |
| 23-CC-4242-20 | 42 | 42 | 29 | \$888 | 175 | 35 |
| 23-CC-3636-24 | 36 | 36 | 29 | \$808 | 135 | 26 |
| 23-CC-4242-24 | 42 | 42 | 29 | \$888 | 175 | 35 |
| 23-Csp-2060 | 20 | 60 | 29 | \$948 | 170 | 25 |
| 23-Csp-2072 | 20 | 72 | 29 | \$1,138 | 182 | 30 |
| 23-Csp-2060-LF w/1 lock w/handles (B1) | 20 | 60 | 29 | \$1,404 | 195 | 25 |
| 23-Csp-2072-LF w/1 lock w/handles (B1) | 20 | 72 | 29 | \$1,404 | 205 | 30 |
| 23-Csp-2072-5DR w/handles (B1) | 20 | 72 | 29 | \$1,452 | 205 | 30 |
| \$210 List to add 6" increments (\$122 List cut downs) | | | | | | |

Sizes are nominal.

2300 Series

Solid Hardwood Edges, Laminate, Available in Four Profiles, Introduce Artistic Flair to These Stylish Designs.

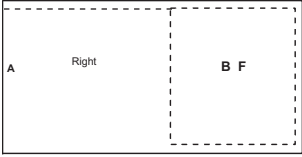
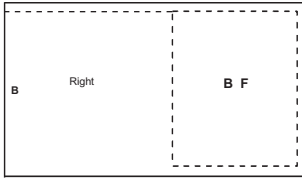
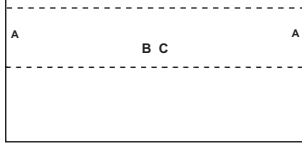
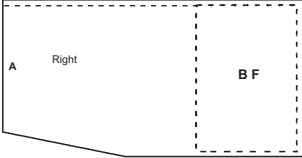
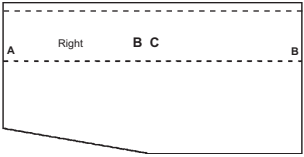
| | Model Number | Depth | Width | Height | List | Weight | Cube |
|---|--|-------|-------|--------|-------|--------|------|
| Returns-20" W/BF Pedestals  | 23-Ret-2042 | 20 | 42 | 29 | \$576 | 85 | 18 |
| | 23-Ret-2047 | 20 | 47 | 29 | \$646 | 95 | 20 |
| | \$210 List to add 6" increments (\$122 List cut downs) | | | | | | |
| Returns-24" W/BF Pedestals  | 23-Ret-2436 | 24 | 36 | 29 | \$690 | 100 | 18 |
| | 23-Ret-2447 | 24 | 47 | 29 | \$690 | 120 | 23 |
| | \$210 List to add 6" increments (\$122 List cut downs) | | | | | | |
| Rectangular Bridges W/Bookcase  | 23-BR-2036-BC | 24 | 36 | 29 | \$614 | 100 | 15 |
| | 23-BR-2447-BC | 24 | 47 | 29 | \$686 | 120 | 23 |
| | \$210 List to add 6" increments (\$122 List cut downs) | | | | | | |
| Angled Returns-24" W/BF Pedestals  | 23-ARet-2436 | 24 | 36 | 29 | \$748 | 100 | 18 |
| | 23-ARet-2447 | 24 | 47 | 29 | \$800 | 115 | 23 |
| | \$210 List to add 6" increments (\$122 List cut downs) | | | | | | |
| Angled Bridge-24" W/Bookcase  | 23-ABr-2436-BC | 24 | 36 | 29 | \$724 | 109 | 18 |
| | 23-ABr-2447BC | 24 | 47 | 29 | \$796 | 115 | 23 |
| | \$210 List to add 6" increments (\$122 List cut downs) | | | | | | |

Sizes are nominal.

2300 Series

Solid Hardwood Edges, Laminate, Available in Four Profiles, Introduce Artistic Flair to These Stylish Designs.

Conference Table Top Edge Details

Tri - Oval

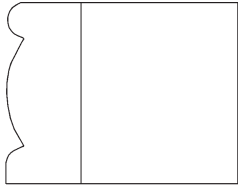

Fluted



Radius

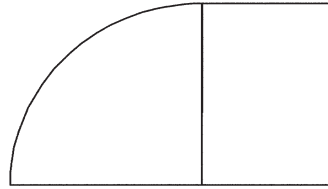

Bevel

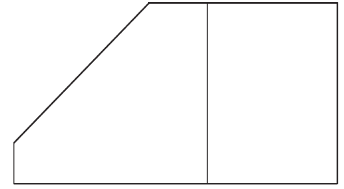

Standard Edge Details

P-11

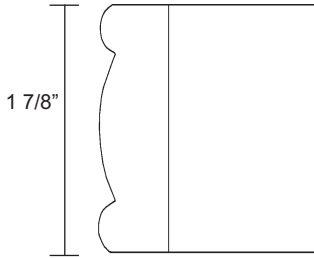

P-12

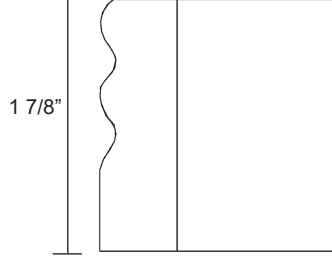

P-13

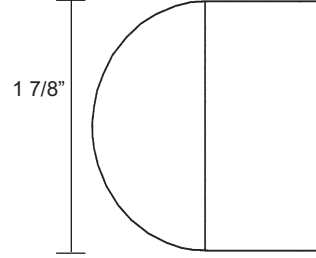

P-14

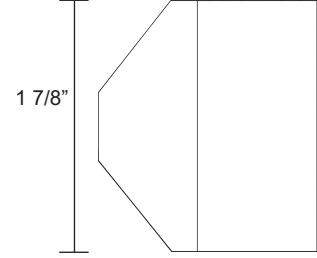

25% Upcharge On 1 7/8" Tops Only

Racetrack Conference Table (RACE)

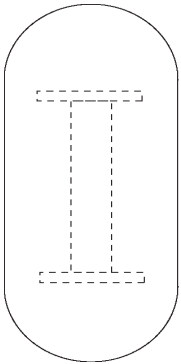

Round Conference Table (RND)

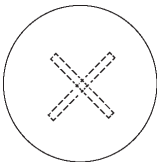

| Model Number | Depth | Width | Height | List | Weight | Cube |
|---|-------------|----------|--------|---------|--------|------|
| 23-3672-RACE | 36 | 72 | 29 | \$1,368 | 135 | 22 |
| • 23-3672-RACE-Top | 36 | 72 | 1.1 | \$1,206 | 85 | 6 |
| • 21-3672-Rec-Boat-BASE | 24 | 31 | 29 | \$162 | 50 | 16 |
| 23-4896-RACE | 48 | 96 | 29 | \$1,562 | 198 | 36 |
| • 23-4896-RACE-Top | 48 | 96 | 1.1 | \$1,352 | 143 | 9 |
| • 21-4896-Rec-Boat-BASE | 24 | 55 | 29 | \$210 | 55 | 27 |
| 23-48120-RACE | 48 | 120 | 29 | \$2,148 | 252 | 50 |
| • 23-48120-RACE-Top | 48 | 120 | 1.1 | \$1,878 | 177 | 11 |
| • 21-48120-Rec-Boat-BASE | 24 | 81 | 29 | \$270 | 75 | 39 |
| 23-48144-RACE | 48 | 144 | 29 | \$2,930 | 312 | 66 |
| • 23-48144-RACE-Top | 48 | 144 | 1.1 | \$2,538 | 212 | 14 |
| • 21-48144-Rec-Boat-Base | 24 | 108 | 29 | \$392 | 100 | 52 |
| Top 2-Piece Base 2-Piece | | | | | | |
| \$350 List to add 12" increments (\$210 List cut downs) | add 50% for | 60" wide | | | | |
| 23-36-RND | 36 | 36 | 29 | \$918 | 100 | 16 |
| • 23-36-RND-Top | 36 | 36 | 1.1 | \$782 | 62 | 3 |
| • 21-X-Base | 24 | 24 | 29 | \$136 | 38 | 13 |
| 23-42-RND | 42 | 42 | 29 | \$978 | 118 | 17 |
| • 23-42-RND-Top | 42 | 42 | 1.1 | \$842 | 80 | 4 |
| • 21-X-Base | 24 | 24 | 29 | \$136 | 38 | 13 |
| 23-48-RND | 48 | 48 | 29 | \$1,134 | 128 | 18 |
| • 23-48-RND-Top | 48 | 48 | 1.1 | \$998 | 90 | 5 |
| • 21-X-Base | 24 | 24 | 29 | \$136 | 38 | 13 |
| add 50% for 60" | | | | | | |

Sizes are nominal.

2300 Series

Solid Hardwood Edges, Laminate, Available in Four Profiles, Introduce Artistic Flair to These Stylish Designs.

Boat Shape Conference Table (BOAT)

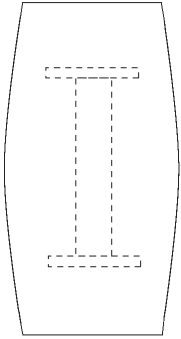

| Model Number | Depth | Width | Height | List | Weight | Cube |
|---|---------|--------------|--------|---------|--------|------|
| 23-3672-Boat | 36 | 72 | 29 | \$1,264 | 135 | 22 |
| • 23-3672-Boat-Top | 36 | 72 | 1.1 | \$1,102 | 85 | 6 |
| • 21-3672-Rec-Boat-BASE | 24 | 31 | 29 | \$162 | 50 | 16 |
| 23-4896-Boat | 48 | 96 | 29 | \$1,370 | 198 | 36 |
| • 23-4896-Boat-Top | 48 | 96 | 1.1 | \$1,160 | 143 | 9 |
| • 21-4896-Rec-Boat-BASE | 24 | 55 | 29 | \$210 | 55 | 27 |
| 23-48120-Boat | 48 | 120 | 29 | \$1,954 | 252 | 50 |
| • 23-48120-Boat-Top | 48 | 120 | 1.1 | \$1,684 | 177 | 11 |
| • 21-48120-Rec-Boat-BASE | 24 | 81 | 29 | \$270 | 75 | 39 |
| 23-48144-Boat | 48 | 144 | 29 | \$2,736 | 312 | 66 |
| • 23-48144-Boat-Top | 48 | 144 | 1.1 | \$2,344 | 212 | 14 |
| • 21-48144-Rec-Boat-Base | 24 | 108 | 29 | \$392 | 100 | 52 |
| Top 2-Piece Base 2-Piece | | | | | | |
| \$350 List to add 12" increments (\$210 List cut downs) | add 50% | for 60" wide | | | | |

Rectangle Conference Table (REC)

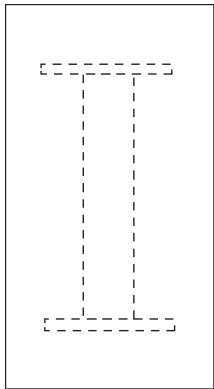

| | | | | | | |
|---|---------|--------------|-----|---------|-----|----|
| 23-3672-Rec | 36 | 72 | 29 | \$1,264 | 135 | 22 |
| • 23-3672-Rec-Top | 36 | 72 | 1.1 | \$1,102 | 85 | 6 |
| • 21-3672-Rec-Boat-BASE | 24 | 31 | 29 | \$162 | 50 | 16 |
| 23-4896-Rec | 48 | 96 | 29 | \$1,368 | 198 | 36 |
| • 23-4896-Rec-Top | 48 | 96 | 1.1 | \$1,158 | 143 | 9 |
| • 21-4896-Rec-Boat-BASE | 24 | 55 | 29 | \$210 | 55 | 27 |
| 23-48120-Rec | 48 | 120 | 29 | \$1,954 | 252 | 50 |
| • 23-48120-Rec-Top | 48 | 120 | 1.1 | \$1,684 | 177 | 11 |
| • 21-48120-Rec-Boat-BASE | 24 | 81 | 29 | \$270 | 75 | 39 |
| 23-48144-Rec | 48 | 144 | 29 | \$2,736 | 312 | 66 |
| • 23-48144-Rec-Top | 48 | 144 | 1.1 | \$2,344 | 212 | 14 |
| • 21-48144-Rec-Boat-Base | 24 | 108 | 29 | \$392 | 100 | 52 |
| Top 2-Piece Base 2-Piece | | | | | | |
| \$350 List to add 12" increments (\$210 List cut downs) | add 50% | for 60" wide | | | | |

Conference Cabinet (CFC)

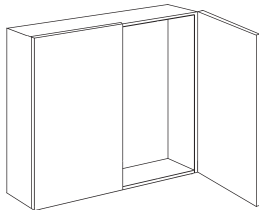

| | | | | | | |
|-------------|---|----|----|---------|----|----|
| 21-CFC-3636 | 5 | 36 | 36 | \$1,366 | 65 | 6 |
| 21-CFC-4848 | 5 | 48 | 48 | \$1,366 | 75 | 11 |
| | | | | | | |
| | | | | | | |
| | | | | | | |
| | | | | | | |
| | | | | | | |
| | | | | | | |
| | | | | | | |

Lectern (LT)

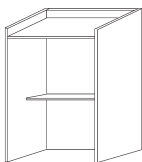

| | | | | | | |
|------------|----|----|----|-------|----|----|
| 21-LT-2030 | 20 | 30 | 46 | \$922 | 95 | 15 |
| | | | | | | |
| | | | | | | |
| | | | | | | |
| | | | | | | |

Sizes are nominal.

2300 Series

Solid Hardwood Edges, Laminate, Available in Four Profiles, Introduce Artistic Flair to These Stylish Designs.

Cylinder Bases

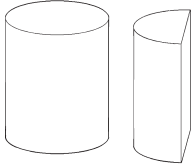

| Model Number | Depth | Width | Height | List | Weight | Cube |
|--|-------|-------|--------|-------|--------|------|
| • 21-Cylinder Base | 18 | 18 | 27 | \$488 | 25 | 10 |
| • 21-1/2 Cylinder Base | 18 | 9 | 27 | \$488 | 18 | 6 |
| All Tables w/ Cylinder Base, Must Be Ordered in Component Pieces | | | | | | |
| add 50% for 30" | | | | | | |

Wall Hanging Overhead (OH)

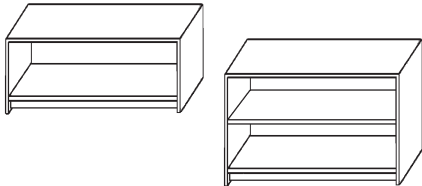

| | | | | | | |
|------------|----|----|----|-------|-----|----|
| 21-OH-1634 | 14 | 34 | 16 | \$586 | 70 | 7 |
| 21-OH-3034 | 14 | 34 | 28 | \$782 | 130 | 11 |

Stand Alone Pedestals (PED)

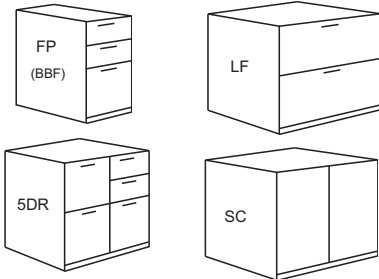

| | | | | | | |
|--|----|----|----|-------|----|----|
| Doors not standard See options for door configurations | | | | | | |
| 21-PED-2017-FP-SA | 19 | 17 | 27 | \$526 | 45 | 7 |
| Specify - Box/Box/File or File/File | | | | | | |
| 21-PED-2036-LF-SA | 19 | 36 | 27 | \$588 | 65 | 14 |
| w/handles (B1) | | | | | | |
| 21-PED-2033-5DR-SA | 19 | 33 | 27 | \$880 | 70 | 13 |
| w/handles (B1) | | | | | | |
| 21-PED-2036-SC-SA | 19 | 36 | 27 | \$588 | 65 | 14 |
| Note - Peds have unfinished backs | | | | | | |
| See hardware for casters | | | | | | |
| Adding casters will make unit 29" high | | | | | | |

Built in Printer and CPU Pullouts (PPO, CPU)

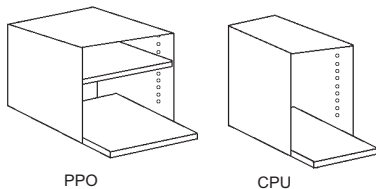

| | | | | | | |
|---|----|----|----|-------|----|--|
| 21-PPO-20 | 19 | 22 | 20 | \$284 | 15 | |
| 21-CPU-PO-20 | 19 | 12 | 20 | \$252 | 10 | |
| 20" depth units only | | | | | | |
| 21-PPO-24 | 23 | 22 | 24 | \$284 | 17 | |
| 21-CPU-PO-24 | 23 | 12 | 24 | \$252 | 12 | |
| 24", 30", 36" depth units only | | | | | | |
| Doors not standard See options for doors | | | | | | |
| Must be added to no ped, full ped, or lat file units only | | | | | | |

Built in Pedestals (PED)

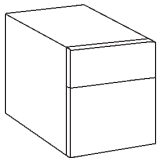

| | | | | | | |
|-----------------------------------|------------|----|----|----|--------|-----|
| 21-PED-2017-BF-BI | add ped | 19 | 17 | 18 | \$240 | 30 |
| | remove ped | | | | -\$176 | -30 |
| 21-PED-2036-LF-BI | add ped | 19 | 36 | 27 | \$588 | 65 |
| 21-PED-2032-5DR-BI | add ped | 19 | 33 | 24 | \$824 | 70 |
| Space Limitations Apply | | | | | | |
| See Options for full ped upcharge | | | | | | |

Sizes are nominal.

2300 Series

Solid Hardwood Edges, Laminate, Available in Four Profiles, Introduce Artistic Flair to These Stylish Designs.

| OPTIONS: | | Depth | Width | Height | List | Weight | Cube |
|--|---|-------|-------|--------|-------|--------|------|
| | Model Number | | | | | | |
| Center Drawer Large | Op-LAM-CD-Large | 20 | 26 | 3 | \$110 | 4 | 2 |
| Center Drawer Small | Op-LAM-CD-Small | 20 | 20 | 3 | \$110 | 4 | 2 |
| Full Pedestal With Lock File File Configuration Or Box Box File Configuration (Includes Full Modesty) | FULL PED | | | | \$212 | 15 | |
| 1/2 Cylinder Base with Full Modesty Panel | Cylinder MOD | | | | \$488 | 40 | |
| Hutch Doors | 21-H-Half Laminate Doors | 1 | | 13 | \$210 | 10 | |
| | 21-CH-Half Laminate Doors | 1 | | 13 | \$210 | 10 | |
| | 21-H-Full Glass Doors | 1 | | 26 | \$856 | 20 | |
| | 21-CH-Full Glass Doors | 1 | | 26 | \$856 | 20 | |
| | 21-H-Upper Half Glass Doors | 1 | | 13 | \$708 | 10 | |
| | 21-CH-Upper Half Glass Doors | 1 | | 13 | \$708 | 10 | |
| Printer and CPU Doors | 21-CPU door | 1 | 12 | 24 | \$78 | 3 | |
| | 21-PPO door | 1 | 21 | 24 | \$78 | 4 | |
| Overhead Doors | Op-OH-Doors | 1 | | 13 | \$105 | 5 | |
| Full Modesty Panel | FULL MOD | | | | \$78 | 10 | |
| COLORS: | | | | | | | |
| Cherry | LCH | | | | | | |
| Dark Cherry | LDC | | | | | | |
| Mahogany | LMA | | | | | | |
| Medium Oak | LMO | | | | | | |
| Walnut | LWA | | | | 5% | | |
| Maple | LMP | | | | | | |
| Folk Stone | LFS (Base only) | | | | | | |
| Slate Grey | LSL (Base only) | | | | | | |
| Black | LBL (Base only) | | | | | | |
| Mixed Colors (Additional Up Charge) | | | | | 5% | | |
| High Pressure Tops | Includes choice from most colors by: Formica, Nevamar, Pionite, & Wilsonart | | | | 20% | | |
| Touch-up Crayons (in all colors) | Specify Color | | | | \$16 | | |
| Touch-up Markers (in all colors) | Specify Color | | | | \$22 | | |

Sizes are nominal.

2300 Series

Solid Hardwood Edges, Laminate, Available in Four Profiles, Introduce Artistic Flair to These Stylish Designs.



| | Model Number | Description | List |
|--|------------------------|--|---------------------------------|
| Grommet | Op-Grom | (Installed) Hardware, Grommet, 60mm Cable, Black | \$62 |
| | Powered Grommet | Op-Pwr-Grom | Retractable Power Grommet black |
| Power Grommets Holds 1 or 2 Data Modules Only. | Op-IL-RJ11-Cat. 3 | In-line data module, RJ 11Cat. 3 black | \$48 |
| | Op-IL-RJ45-Cat. 3 | In-line data module, RJ 45 Cat. 3 black | \$48 |
| | Op-HW-RJ11-Cat. 3 | Hard wire data module, RJ 11 Cat. 3 black | \$48 |
| | Op-HW-RJ45-Cat. 3 | Hard wire data module, RJ 45 Cat. 3 black | \$48 |
| | Op-HW-RJ45-Cat. 5 | Hard wire data module, RJ 45 Cat. 5 black | \$48 |
| | Op-HW-RJ45-Cat. 6 | Hard wire data module, RJ 45 Cat. 6 orange | \$82 |

Grommet Placement Guide

When choosing an optional grommet, please use the drawings below to determine where you would like the grommet placed on the worksurface. For grommet placement in the modesty panels, place an "M" ahead of the number. Grommets through modesty panels are positioned at the highest possible point on the modesty panel. For example: To have the grommet placed in the center of the modesty panel of a return, indicate "M1" on the order line for that item.

Please Note: Grommets cannot go through pedestals on 20" depth units.

Single Pedestal Right

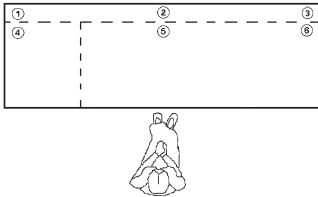

Single Pedestal Left

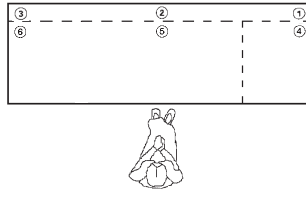

Double Pedestal

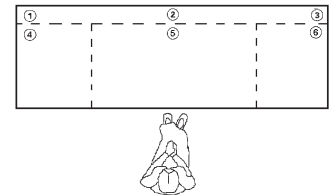

Computer Corner Credenzas

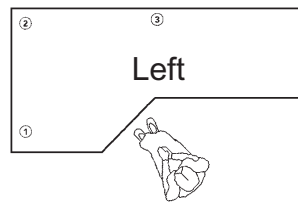
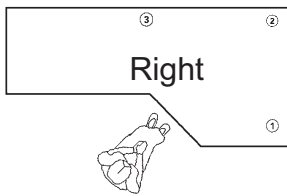

Credenzas

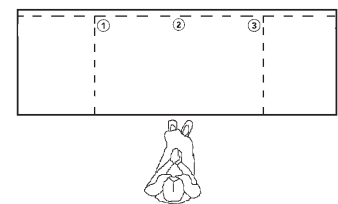

Return Right

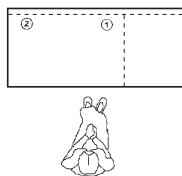

Return Left

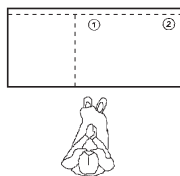

Conference Tables

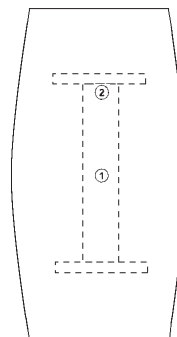

Bullet/P-tops

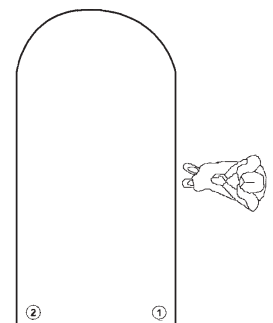

Computer Corner

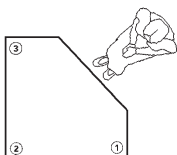

Bridges

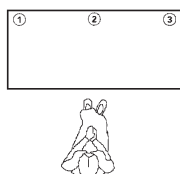

2300 Series

Solid Hardwood Edges, Laminate, Available in Four Profiles, Introduce Artistic Flair to These Stylish Designs.



Crescent Pull



Wire Pull



Button Pull



Tab Pull



Standard Pull



Traditional Pull



| Model Number | Description | Width | Height | Depth | List |
|--------------|--------------------------|-------|--------|-------|------|
| Op-B1 | Standard Pull Black | 278mm | 18mm | 10mm | \$38 |
| Op-N1 | Standard Pull Nickel | 278mm | 18mm | 10mm | \$38 |
| Op-B2 | Tab Pull Black | 40mm | 26mm | 8mm | \$38 |
| Op-N2 | Tab Pull Nickel | 40mm | 26mm | 8mm | \$38 |
| Op-B3 | Wire Pull Black | 153mm | 30mm | 10mm | \$38 |
| Op-N3 | Wire Pull Nickel | 153mm | 30mm | 10mm | \$38 |
| Op-B4 | Button Pull Black | 31mm | 28mm | 15mm | \$38 |
| Op-N4 | Button Pull Nickel | 31mm | 28mm | 15mm | \$38 |
| Op-B5 | Crescent Pull Black | 100mm | 24mm | 22mm | \$38 |
| Op-N5 | Crescent Pull Nickel | 100mm | 24mm | 22mm | \$38 |
| Op-A6 | Traditional Pull Antique | 147mm | 48mm | 14mm | \$38 |

HARDWARE:

| | | Depth | Width | Height | List | Weight | Cube |
|---|--|-------|-------|--------|-------|--------|------|
| Standard Keyboard Tray | KBT-Standard | 20 | 22 | 2 | \$118 | 10 | 2 |
| Standard Keyboard Tray With Mouse Tray | KBT-Standard-MT | 20 | 22 | 3 | \$196 | 10 | 2 |
| Keyboard Tray With Articulating Arm and Mouse Tray | KBT-ArtArm-MT | 20 | 27 | 4 | \$356 | 10 | 2 |
| Desk Lock | Op-DESK-LOCK | | | | \$62 | | |
| Casters | OP-Casters (add 2" to height) | | | 2 | \$128 | | |
| Cartoning | Corner guards, cardboard top, & sides (Priced per box) | | | | \$74 | | |
| | Bubble Wrap | | | | \$74 | | |
| | Bubble Wrap & Palletize | | | | \$126 | | |

Sizes are nominal.

NOTES

3300 Series

Solid Hardwood Edges, Laminate, Available in Four Profiles, Introduce Artistic Flair to These Stylish Designs.

Standard Features:

- Full Suspension on all Drawers.
- Box/Box/File Pedestals w/handles (Op-B1).
- 1/2" 9 Ply UV Coated Birch Drawer Material
- Touch Latch Doors on Credenzas.
- File Drawers Supplied with Rods for Hanging Legal and Letter Files.
- Solid Hardwood 4 Way Edges on Top Available in Four Profiles.

- Matching Vertical Grain Drawer Fronts.
- 20" Depth on Credenzas and Lateral Files.
- Vertical Grain Full Modesty Panels.
- Adjustable Leveling Glides (except Bookcases).
- Thermofused Laminate on Tops.
- Locks Keyed Alike.

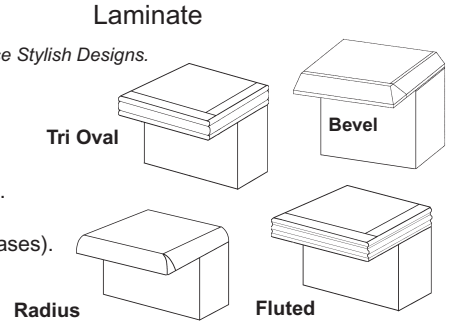

Desks - Double Pedestal/Single Pedestal/ Fan Desk/ (DP, FDP, SP)

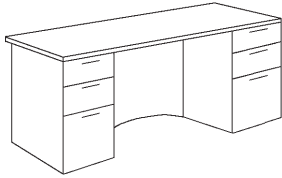

| Model Number | Depth | Width | Height | List | Weight | Cube |
|--|-------|-------|--------|---------|--------|------|
| 33-DP-3060 w/1 lock | 30 | 60 | 29 | \$1,320 | 265 | 36 |
| 33-DP-3066 w/1 lock | 30 | 66 | 29 | \$1,436 | 275 | 40 |
| 33-DP-3672 w/1 lock | 36 | 72 | 29 | \$1,482 | 305 | 51 |
| 33-SP-2448 w/1 lock | 24 | 48 | 29 | \$1,036 | 135 | 24 |
| 33-SP-3048 w/1 lock | 30 | 48 | 29 | \$1,072 | 145 | 29 |
| Floating top option available, See options. | | | | | | |
| \$210 List to add 6" increments (\$122 List cut downs) | | | | | | |
| 33-FDP-3672 w/1 lock | 42 | 72 | 29 | \$1,738 | 300 | 59 |
| 33-FDP-3066 w/1 lock | 36 | 66 | 29 | \$1,694 | 295 | 51 |
| Floating top option available, See options. | | | | | | |
| \$298 List to add 6" increments (\$210 List cut downs) | | | | | | |

Credenzas (C-Open/C-Cab)

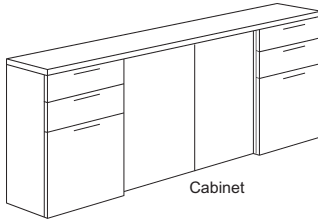

| | | | | | | |
|--|----|----|----|---------|-----|----|
| 33-C-2060-Cab | 20 | 60 | 29 | \$1,320 | 223 | 25 |
| 33-C-2060-Open | 20 | 60 | 29 | \$1,320 | 205 | 25 |
| 33-C-2066-Cab | 20 | 66 | 29 | \$1,436 | 227 | 27 |
| 33-C-2066-Open | 20 | 66 | 29 | \$1,436 | 211 | 27 |
| 33-C-2072-Cab | 20 | 72 | 29 | \$1,482 | 235 | 30 |
| 33-C-2072-Open | 20 | 72 | 29 | \$1,482 | 217 | 30 |
| Floating top option available, See options. | | | | | | |
| 24" Credenza depth add \$210 List | | | | | | |
| \$210 List to add 6" increments (\$122 List cut downs) | | | | | | |

Desks with Return (DR)

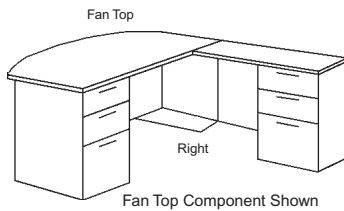
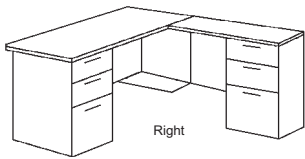

| | | | | | | |
|------------------------|----|----|----|---------|-----|----|
| 33-DR-3060-2042 | 72 | 60 | 29 | \$1,918 | 280 | 54 |
| • 33-Dsp-3060 w/1 lock | 30 | 60 | 29 | \$1,146 | 195 | 36 |
| • 33-Ret-2042 | 20 | 42 | 29 | \$772 | 85 | 18 |
| 33-DR-3066-2447 | 77 | 66 | 29 | \$2,206 | 335 | 63 |
| • 33-Dsp-3066 w/1 lock | 30 | 66 | 29 | \$1,280 | 215 | 40 |
| • 33-Ret-2447 | 24 | 47 | 29 | \$926 | 120 | 23 |
| 33-DR-3672-2047 | 83 | 72 | 29 | \$2,246 | 320 | 71 |
| • 33-Dsp-3672 w/1 lock | 36 | 72 | 29 | \$1,378 | 225 | 51 |
| • 33-Ret-2047 | 20 | 47 | 29 | \$868 | 95 | 20 |
| 33-DR-3672-2447 | 83 | 72 | 29 | \$2,304 | 345 | 74 |
| • 33-Dsp-3672 w/1 lock | 36 | 72 | 29 | \$1,378 | 225 | 51 |
| • 33-Ret-2447 | 24 | 47 | 29 | \$926 | 120 | 23 |

Fan & P-Top Available (See Components)

Floating top option available, See options.

\$210 List to add 6" increments (\$122 List cut downs)

Sizes are nominal.

3300 Series

Solid Hardwood Edges, Laminate, Available in Four Profiles, Introduce Artistic Flair to These Stylish Designs.

Work Tables (WT)

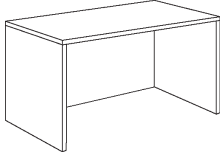

| Model Number | Depth | Width | Height | List | Weight | Cube |
|--------------|-------|-------|--------|-------|--------|------|
| 33-WT-2036 | 20 | 36 | 29 | \$472 | 65 | 15 |
| 33-WT-2042 | 20 | 42 | 29 | \$588 | 85 | 18 |
| 33-WT-2048 | 20 | 48 | 29 | \$612 | 95 | 20 |
| 33-WT-2060 | 20 | 60 | 29 | \$646 | 100 | 25 |
| 33-WT-2072 | 20 | 72 | 29 | \$792 | 115 | 30 |
| 33-WT-2448 | 24 | 48 | 29 | \$612 | 110 | 24 |
| 33-WT-3048 | 30 | 48 | 29 | \$646 | 130 | 29 |
| 33-WT-3060 | 30 | 60 | 29 | \$754 | 140 | 36 |
| 33-WT-3672 | 36 | 72 | 29 | \$838 | 160 | 51 |

Floating top option available, See options.

\$210 List to add 6" increments (\$122 List cut downs)

Lateral Files (LF)

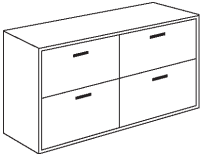

| | | | | | | |
|------------------------------|----|----|----|---------|-----|----|
| 33-LF-2038-2D w/handles (B1) | 20 | 38 | 29 | \$774 | 170 | 15 |
| 33-LF-2072-4D w/handles (B1) | 20 | 72 | 29 | \$1,440 | 330 | 30 |
| Locks Standard | | | | | | |

Floating top option available, See options.

For:

- Bookcases
- Conference Tables
- End Tables
- Hutches
- Reception Units
- Storage Cabinets
and
- Other Items

See 2300 Series

Sizes are nominal.

3300 Series

Solid Hardwood Edges, Laminate, Available in Four Profiles, Introduce Artistic Flair to These Stylish Designs.

Computer U-Shape Desks (CU)

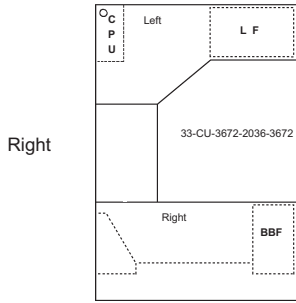

U-Shape Desks (NCU)

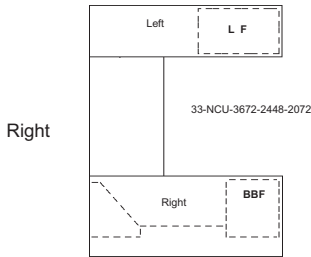

Bullet Computer U-Shape Desks (BCU)

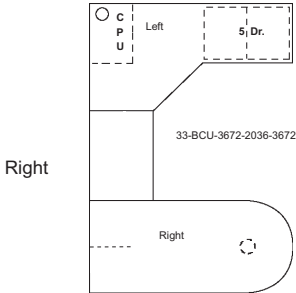

Bullet U-Shape Desks (BNCU)

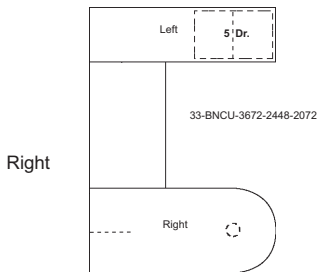

Computer Corner with Return (CR)

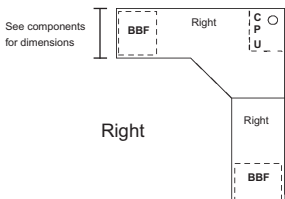

| Model Number | Depth | Width | Height | List | Weight | Cube |
|---|-------|-------|--------|---------|--------|------|
| 33-CU-3066-2036-3666 | 102 | 66 | 29 | \$3,374 | 520 | 102 |
| • 33-Dsp-3066 w/1 lock | 30 | 66 | 29 | \$1,280 | 215 | 40 |
| • 33-BR-2036-BC | 20 | 36 | 29 | \$614 | 100 | 15 |
| • 33-CCCsp-3666 | 36 | 66 | 29 | \$1,480 | 205 | 47 |
| 33-CU-3672-2036-3672 | 108 | 72 | 29 | \$3,586 | 575 | 117 |
| • 33-Dsp-3672 w/1 lock | 36 | 72 | 29 | \$1,378 | 225 | 51 |
| • 33-BR-2036-BC | 20 | 36 | 29 | \$614 | 100 | 15 |
| • 33-CCCsp-3672-LF w/1 lock | 36 | 72 | 29 | \$1,594 | 250 | 51 |
| w/handles (B1) | | | | | | |
| Floating top option available, See options. | | | | | | |
| See Components for cut downs | | | | | | |
| 33-NCU-3672-2448-2072 | 103 | 72 | 29 | \$3,466 | 550 | 104 |
| • 33-Dsp-3672 w/1 lock | 36 | 72 | 29 | \$1,378 | 225 | 51 |
| • 33-BR-2448-BC | 24 | 47 | 29 | \$686 | 120 | 23 |
| • 33-Csp-2072-LF w/1 lock | 20 | 72 | 29 | \$1,402 | 205 | 30 |
| w/handles (B1) | | | | | | |
| Floating top option available, See options. | | | | | | |
| See Components for cut downs | | | | | | |
| 33-BCU-3672-2036-3672 | 108 | 72 | 29 | \$3,908 | 490 | 117 |
| • 33-B-3672 | 36 | 72 | 29 | \$1,626 | 140 | 51 |
| • 33-BR-2036-BC | 20 | 36 | 29 | \$614 | 100 | 15 |
| • 33-CCCsp-3672-5Dr | 36 | 72 | 29 | \$1,668 | 250 | 51 |
| w/handles (B1) | | | | | | |
| Cylinder MOD Optional | | | | | | |
| 33-BCU-3684-2036-3672 | 108 | 84 | 29 | \$4,012 | 505 | 125 |
| • 33-B-3684 | 36 | 84 | 29 | \$1,730 | 155 | 59 |
| • 33-BR-2036-BC | 20 | 36 | 29 | \$614 | 100 | 15 |
| • 33-CCCsp-3672-5Dr | 36 | 72 | 29 | \$1,668 | 250 | 51 |
| w/handles (B1) | | | | | | |
| Cylinder MOD Optional | | | | | | |
| Floating top option available, See options. | | | | | | |
| See Components for cut downs | | | | | | |
| 33-BNCU-3672-2448-2072 | 103 | 72 | 29 | \$3,764 | 465 | 104 |
| • 33-B-3672 | 36 | 72 | 29 | \$1,626 | 140 | 51 |
| • 33-BR-2447-BC | 24 | 47 | 29 | \$686 | 120 | 23 |
| • 33-Csp-2072-5DR | 20 | 72 | 29 | \$1,452 | 205 | 30 |
| w/handles (B1) | | | | | | |
| Cylinder MOD Optional | | | | | | |
| Fan & P-Top Available (See Components) | | | | | | |
| Floating top option available, See options. | | | | | | |
| See Components for cut downs | | | | | | |
| 33-CR-3666-2042 | 78 | 66 | 29 | \$2,252 | 290 | 65 |
| • 33-CCCsp-3666 | 36 | 66 | 29 | \$1,480 | 205 | 47 |
| • 33-Ret-2042-BF | 20 | 42 | 29 | \$772 | 85 | 18 |
| 33-CR-3672-2447 | 83 | 72 | 29 | \$2,406 | 335 | 74 |
| • 33-CCDsp-3672 | 36 | 72 | 29 | \$1,480 | 215 | 51 |
| • 33-Ret-2447 | 24 | 47 | 29 | \$926 | 120 | 23 |
| Floating top option available, See options. | | | | | | |
| See Components for cut downs | | | | | | |

Sizes are nominal.

3300 Series

Solid Hardwood Edges, Laminate, Available in Four Profiles, Introduce Artistic Flair to These Stylish Designs.

How to Specify Left or Right Components

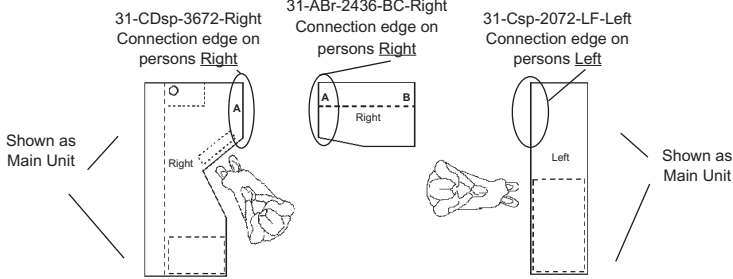

“Right” = Connects to Right side of main desk.

“Left” = Connects to Left side of main desk.

“A” = 20” Width

“B” = 24” Width

Components

Desk Tops

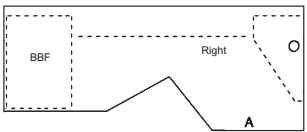
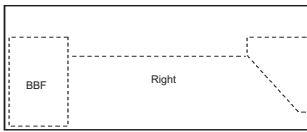

Fan Tops

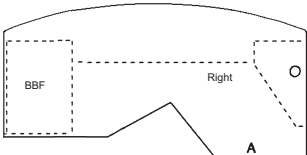
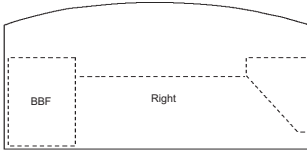

Bullet Tops



Computer Bullet Tops

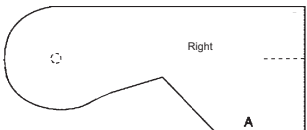

P-Tops

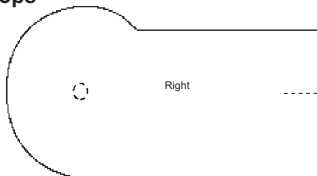

| Model Number | Depth | Width | Height | List | Weight | Cube |
|---|-------|-------|--------|---------|--------|------|
| 33-Dsp-3060 w/1 lock | 30 | 60 | 29 | \$1,146 | 195 | 36 |
| 33-Dsp-3066 w/1 lock | 30 | 66 | 29 | \$1,280 | 215 | 40 |
| 33-Dsp-3672 w/1 lock | 36 | 72 | 29 | \$1,378 | 225 | 51 |
| Floating top option available, See options. \$210 List to add 6" increments (\$122 List cut downs) | | | | | | |
| 33-CDsp-3672 w/1 lock | 36 | 72 | 29 | \$1,774 | 215 | 51 |
| Floating top option available, See options. | | | | | | |
| 33-FDsp-3066 w/1 lock | 36 | 66 | 29 | \$1,784 | | 51 |
| 33-FDsp-3672 w/1 lock | 42 | 72 | 29 | \$1,892 | 255 | 59 |
| Floating top option available, See options. \$298 List to add 6" increments (\$210 List cut downs) | | | | | | |
| 33-FCDsp-3672 w/1 lock | 42 | 72 | 29 | \$2,040 | 250 | 59 |
| Floating top option available, See options. | | | | | | |
| 33-B-3672 | 36 | 72 | 29 | \$1,626 | 140 | 51 |
| 33-B-3684 | 36 | 84 | 29 | \$1,730 | 155 | 59 |
| Cylinder MOD Optional | | | | | | |
| Floating top option available, See options. \$298 List to add 6" increments (\$210 List cut downs) | | | | | | |
| 33-CB-3672 | 36 | 72 | 29 | \$1,902 | 135 | 51 |
| 33-CB-3684 | 36 | 84 | 29 | \$2,008 | 145 | 59 |
| Cylinder MOD Optional | | | | | | |
| Floating top option available, See options. | | | | | | |
| 33-P-3672 | 42 | 72 | 29 | \$1,868 | 180 | 59 |
| Cylinder MOD Optional | | | | | | |
| Floating top option available, See options. \$298 List to add 6" increments (\$210 List cut downs) | | | | | | |

Sizes are nominal.

3300 Series

Solid Hardwood Edges, Laminate, Available in Four Profiles, Introduce Artistic Flair to These Stylish Designs.

Computer P-Tops

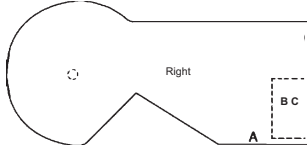

Computer Corners & Credenzas

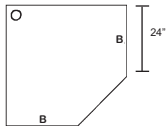
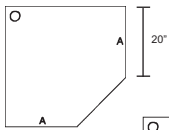
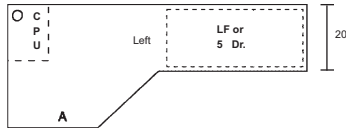
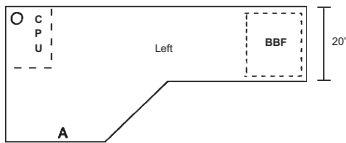
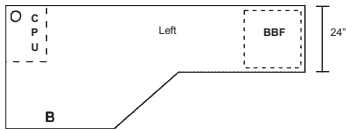



| Model Number | Depth | Width | Height | List | Weight | Cube |
|---|-------|-------|--------|---------|--------|------|
| 33-CP-3672 Cylinder MOD Optional | 48 | 72 | 29 | \$2,054 | 160 | 67 |
| Floating top option available, See options. | | | | | | |
| 33-CCDsp-3672 | 36 | 72 | 29 | \$1,480 | 215 | 51 |
| 33-CCCsp-3666 | 36 | 66 | 29 | \$1,480 | 205 | 47 |
| 33-CCCsp-3672 | 36 | 72 | 29 | \$1,480 | 215 | 51 |
| 33-CCCsp-3672-LF w/1 lock w/handles (B1) | 36 | 72 | 29 | \$1,594 | 250 | 51 |
| 33-CCCsp-3672-5DR w/handles (B1) | 36 | 72 | 29 | \$1,668 | 250 | 51 |
| Floating top option available, See options. \$210 List to add 6" increments (\$176 List cut downs) | | | | | | |
| 33-CC-3636-20 | 36 | 36 | 29 | \$808 | 135 | 26 |
| 33-CC-4242-20 | 42 | 42 | 29 | \$888 | 175 | 35 |
| 33-CC-3636-24 | 36 | 36 | 29 | \$808 | 135 | 26 |
| 33-CC-4242-24 | 42 | 42 | 29 | \$888 | 175 | 35 |
| Floating top option available, See options. | | | | | | |
| 33-Csp-2060 | 20 | 60 | 29 | \$1,146 | 170 | 25 |
| 33-Csp-2072 | 20 | 72 | 29 | \$1,378 | 182 | 30 |
| 33-Csp-2060-LF w/1 lock w/handles (B1) | 20 | 60 | 29 | \$1,402 | 195 | 25 |
| 33-Csp-2072-LF w/1 lock w/handles (B1) | 20 | 72 | 29 | \$1,402 | 205 | 30 |
| 33-Csp-2072-5DR w/handles (B1) | 20 | 72 | 29 | \$1,452 | 205 | 30 |
| Floating top option available, See options. \$210 List to add 6" increments (\$122 List cut downs) | | | | | | |

Sizes are nominal.

3300 Series

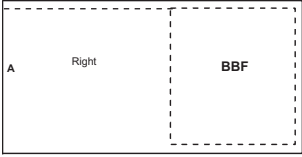
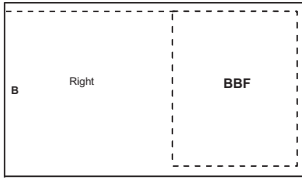
Solid Hardwood Edges, Laminate, Available in Four Profiles, Introduce Artistic Flair to These Stylish Designs.

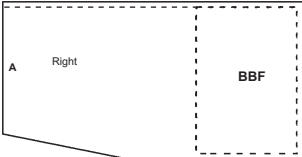
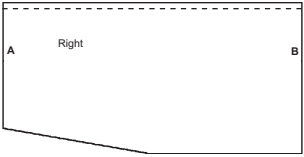
| | Model Number | Depth | Width | Height | List | Weight | Cube |
|--|---|-------|-------|--------|-------|--------|------|
| Returns-20" W/BBF Pedestals  | 33-Ret-2042 | 20 | 42 | 29 | \$772 | 85 | 18 |
| | 33-Ret-2047 | 20 | 47 | 29 | \$868 | 95 | 20 |
| | Floating top option available, See options. \$210 List to add 6" increments (\$122 List cut downs) | | | | | | |
| Returns-24" W/BBF Pedestals  | 33-Ret-2436 | 24 | 36 | 29 | \$926 | 100 | 18 |
| | 33-Ret-2447 | 24 | 47 | 29 | \$926 | 120 | 23 |
| | Floating top option available, See options. \$210 List to add 6" increments (\$122 List cut downs) | | | | | | |
| Rectangular Bridges  | 33-BR-2036 | 24 | 36 | 29 | \$614 | 100 | 15 |
| | 33-BR-2447 | 24 | 47 | 29 | \$686 | 120 | 23 |
| | Floating top option available, See options. \$210 List to add 6" increments (\$122 List cut downs) | | | | | | |
| Angled Returns-24" W/BBF Pedestals  | 33-ARet-2436 | 24 | 36 | 29 | \$904 | 100 | 18 |
| | 33-ARet-2447 | 24 | 47 | 29 | \$968 | 115 | 23 |
| | Floating top option available, See options. \$210 List to add 6" increments (\$122 List cut downs) | | | | | | |
| Angled Bridge-24"  | 33-ABr-2436 | 24 | 36 | 29 | \$724 | 109 | 18 |
| | 33-ABr-2447 | 24 | 47 | 29 | \$796 | 115 | 23 |
| | Floating top option available, See options. \$210 List to add 6" increments (\$122 List cut downs) | | | | | | |

Sizes are nominal.

3300 Series

Solid Hardwood Edges, Laminate, Available in Four Profiles, Introduce Artistic Flair to These Stylish Designs.

| OPTIONS: | | Model Number | Depth | Width | Height | List | Weight | Cube |
|---|--|---|-------|-------|--------|-------|--------|------|
| Center Drawer Large | | Op-LAM-CD-Large | 20 | 26 | 3 | \$110 | 4 | 2 |
| Center Drawer Small | | Op-LAM-CD-Small | 20 | 20 | 3 | \$110 | 4 | 2 |
| 1/2 Cylinder Base with Full Modesty Panel | | Op-Cylinder MOD | | | | \$488 | 40 | |
| Perforated Metal Modesty Panel | | Op-Metal MOD (Nickel) | | | | \$312 | | |
| | | Op-Metal MOD (Black) | | | | \$312 | | |
| Floating Top | | Op-Float Top (Nickel) (per piece) | | | 2 | \$368 | | |
| | | Op-Float Top (Black) (per piece) | | | 2 | \$368 | | |
| Convert Box/Box/File Ped to File/File Ped | | Specify File/File | | | | N/C | | |
| COLORS: | | | | | | | | |
| Cherry | | LCH | | | | | | |
| Dark Cherry | | LDC | | | | | | |
| Mahogany | | LMA | | | | | | |
| Medium Oak | | LMO | | | | | | |
| Walnut | | LWA | | | | 5% | | |
| Maple | | LMP | | | | | | |
| Folk Stone | | LFS (Base only) | | | | | | |
| Slate Grey | | LSL (Base only) | | | | | | |
| Black | | LBL (Base only) | | | | | | |
| Mixed Colors (Additional Up Charge) | | | | | | 5% | | |
| High Pressure Tops | | Includes choice from most colors by: Formica, Nevamar, Pionite, & Wilsonart | | | | 20% | | |
| | | Please call for pricing on custom stain matches on hardwood edge | | | | | | |
| Touch-up Crayons (in all colors) | | Specify Color | | | | \$16 | | |
| Touch-up Markers (in all colors) | | Specify Color | | | | \$22 | | |

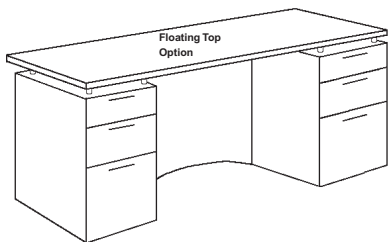

Sizes are nominal.

3300 Series

Solid Hardwood Edges, Laminate, Available in Four Profiles, Introduce Artistic Flair to These Stylish Designs.



| | Model Number | Description | List |
|------------------------|-------------------|--|-------|
| Grommet | Op-Grom | (Installed) Hardware, Grommet, 60mm Cable, Black | \$62 |
| | Op-Pwr-Grom | Retractable Power Grommet black | \$434 |
| Powered Grommet | Op-IL-RJ11-Cat. 3 | In-line data module, RJ 11Cat. 3 black | \$48 |
| | Op-IL-RJ45-Cat. 3 | In-line data module, RJ 45 Cat. 3 black | \$48 |
| | Op-HW-RJ11-Cat. 3 | Hard wire data module, RJ 11 Cat. 3 black | \$48 |
| | Op-HW-RJ45-Cat. 3 | Hard wire data module, RJ 45 Cat. 3 black | \$48 |
| | Op-HW-RJ45-Cat. 5 | Hard wire data module, RJ 45 Cat. 5 black | \$48 |
| | Op-HW-RJ45-Cat. 6 | Hard wire data module, RJ 45 Cat. 6 orange | \$82 |

Power Grommets Holds 1 or 2 Data Modules Only.

Grommet Placement Guide

When choosing an optional grommet, please use the drawings below to determine where you would like the grommet placed on the worksurface. For grommet placement in the modesty panels, place an "M" ahead of the number. Grommets through modesty panels are positioned at the highest possible point on the modesty panel. For example: To have the grommet placed in the center of the modesty panel of a return, indicate "M1" on the order line for that item.

Please Note: Grommets cannot go through pedestals on 20" depth units.

Single Pedestal Right

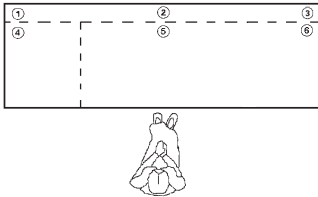

Single Pedestal Left

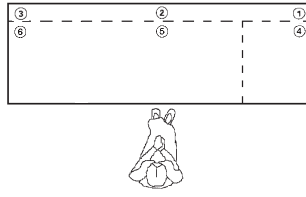

Double Pedestal

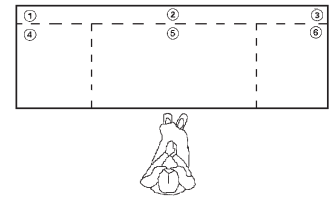

Computer Corner Credenzas

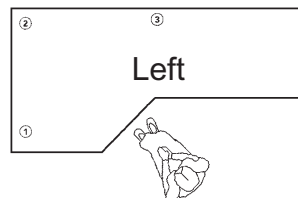
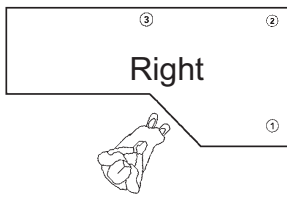

Credenzas

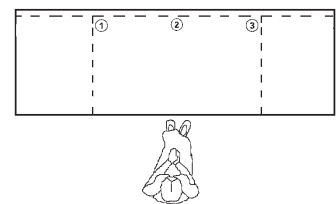

Return Right

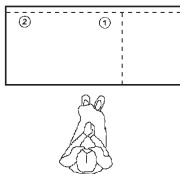

Return Left

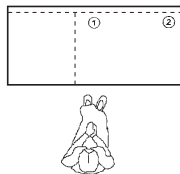

Conference Tables

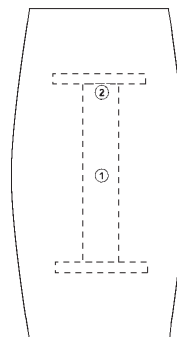

Bullet/P-tops

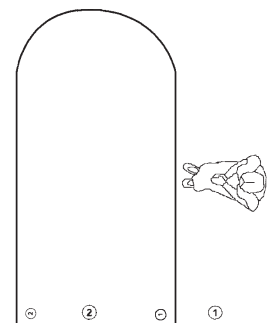

Computer Corner

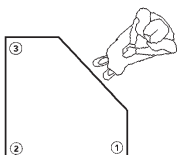

Bridges

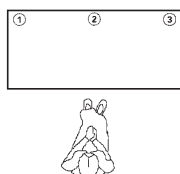

3300

3300 Series

Solid Hardwood Edges, Laminate, Available in Four Profiles, Introduce Artistic Flair to These Stylish Designs.



Crescent Pull



Wire Pull



Button Pull



Tab Pull



Standard Pull



Traditional Pull



| Model Number | Description | Width | Height | Depth | List |
|--------------|--------------------------|-------|--------|-------|------|
| Op-B1 | Standard Pull Black | 278mm | 18mm | 10mm | \$38 |
| Op-N1 | Standard Pull Nickel | 278mm | 18mm | 10mm | \$38 |
| Op-B2 | Tab Pull Black | 40mm | 26mm | 8mm | \$38 |
| Op-N2 | Tab Pull Nickel | 40mm | 26mm | 8mm | \$38 |
| Op-B3 | Wire Pull Black | 153mm | 30mm | 10mm | \$38 |
| Op-N3 | Wire Pull Nickel | 153mm | 30mm | 10mm | \$38 |
| Op-B4 | Button Pull Black | 31mm | 28mm | 15mm | \$38 |
| Op-N4 | Button Pull Nickel | 31mm | 28mm | 15mm | \$38 |
| Op-B5 | Crescent Pull Black | 100mm | 24mm | 22mm | \$38 |
| Op-N5 | Crescent Pull Nickel | 100mm | 24mm | 22mm | \$38 |
| Op-A6 | Traditional Pull Antique | 147mm | 48mm | 14mm | \$38 |

HARDWARE:

| | | Depth | Width | Height | List | Weight | Cube |
|---|--|-------|-------|--------|-------|--------|------|
| Standard Keyboard Tray | KBT-Standard | 20 | 22 | 2 | \$118 | 10 | 2 |
| Standard Keyboard Tray With Mouse Tray | KBT-Standard-MT | 20 | 22 | 3 | \$196 | 10 | 2 |
| Keyboard Tray With Articulating Arm and Mouse Tray | KBT-ArtArm-MT | 20 | 27 | 4 | \$356 | 10 | 2 |
| Desk Lock | Op-DESK-LOCK | | | | \$62 | | |
| Casters | OP-Casters (add 2" to height) | | | 2 | \$128 | | |
| Cartoning | Corner guards, cardboard top, & sides (Priced per box) | | | | \$74 | | |
| | Bubble Wrap | | | | \$74 | | |
| | Bubble Wrap & Palletize | | | | \$126 | | |

Sizes are nominal.

Congress Series

Laminate Traditional Styling, Adds Elegance in the Office.

Laminate

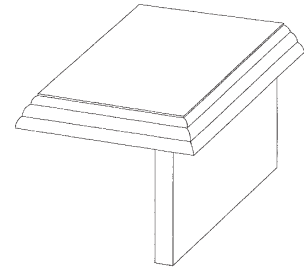

Congress

Standard Features:

- 4-way Solid Hardwood Traditional Molding.
- Dictation Pull-Outs.
- Full Pedestal with Box/Box/File.
- Full Modesty Panels Standard.
- High pressure laminate tops with high gloss finish.
- Center Drawer on Desks.
- 1/2" 9 Ply UV Coated Birch Drawer Material.

Desks - Double/Single Pedestal (DP, SP)

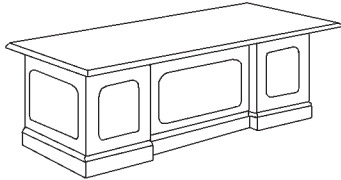

| Model Number | Depth | Width | Height | List | Weight | Cube |
|--|-------|-------|--------|---------|--------|------|
| CG-DP-3066 w/1 lock | 30 | 66 | 29 | \$1,418 | 275 | 40 |
| CG-DP-3672 w/1 lock | 36 | 72 | 29 | \$1,470 | 305 | 51 |
| CG-SP-2450 w/1 lock | 24 | 50 | 29 | \$946 | 135 | 24 |
| CG-SP-3066 w/1 lock | 30 | 66 | 29 | \$1,270 | 215 | 40 |
| \$264 List to add 6" increments (\$176 List cut downs) | | | | | | |

Credenzas (C-Open/C-Cab)

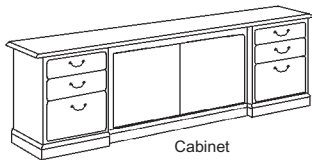

Cabinet

| | | | | | | |
|--|----|----|----|---------|-----|----|
| CG-C-2266-Cab | 22 | 66 | 29 | \$1,418 | 228 | 27 |
| CG-C-2272-Cab | 22 | 72 | 29 | \$1,470 | 235 | 30 |
| CG-C-2266-Open | 22 | 66 | 29 | \$1,418 | 210 | 27 |
| CG-C-2272-Open | 22 | 72 | 29 | \$1,470 | 217 | 30 |
| \$264 List to add 6" increments (\$176 List cut downs) | | | | | | |

Desks with Return (DR)

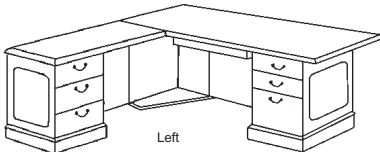

Left

| | | | | | | |
|--|----|----|----|---------|-----|----|
| CG-DR-3066-2448 | 78 | 66 | 29 | \$2,132 | 335 | 63 |
| • CG-Dsp-3066 w/1 lock | 30 | 66 | 29 | \$1,344 | 215 | 40 |
| • CG-Ret-2448 | 24 | 48 | 29 | \$788 | 120 | 23 |
| CG-DR-3672-2448 | 84 | 72 | 29 | \$2,206 | 345 | 74 |
| • CG-Dsp-3672 w/1 lock | 36 | 72 | 29 | \$1,418 | 225 | 51 |
| • CG-Ret-2448 | 24 | 48 | 29 | \$788 | 120 | 23 |
| CG-DR-3672-2460 | 96 | 72 | 29 | \$2,416 | 360 | 78 |
| • CG-Dsp-3672 w/1 lock | 36 | 72 | 29 | \$1,418 | 225 | 51 |
| • CG-Ret-2460 | 24 | 60 | 29 | \$998 | 135 | 27 |
| \$264 List to add 6" increments (\$176 List cut downs) | | | | | | |

Executive U-Shape Workstations (NCU)

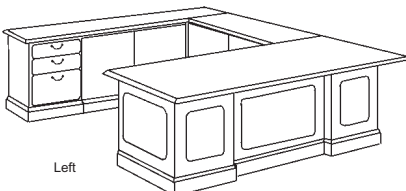

Left

| | | | | | | |
|-----------------------------|-----|----|----|---------|-----|-----|
| CG-NCU-3066-2448-2266 | 100 | 66 | 29 | \$3,340 | 545 | 90 |
| • CG-Dsp-3066 w/1 lock | 30 | 66 | 29 | \$1,344 | 215 | 40 |
| • CG-BR-2448 | 24 | 48 | 29 | \$652 | 120 | 23 |
| • CG-Csp-2266-Closed | 22 | 66 | 29 | \$1,344 | 210 | 27 |
| CG-NCU-3672-2448-2272 | 106 | 72 | 29 | \$3,488 | 562 | 104 |
| • CG-Dsp-3672 w/1 lock | 36 | 72 | 29 | \$1,418 | 225 | 51 |
| • CG-BR-2448 | 24 | 48 | 29 | \$652 | 120 | 23 |
| • CG-Csp-2272-Closed | 22 | 72 | 29 | \$1,418 | 217 | 30 |
| See components for cutdowns | | | | | | |

Sizes are nominal.

Congress Series

Laminate Traditional Styling, Adds Elegance in the Office.

Computer U-Shape Desks (CU)

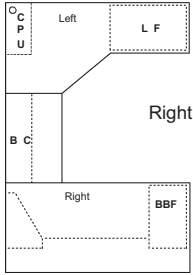

Reception Units (Recep)

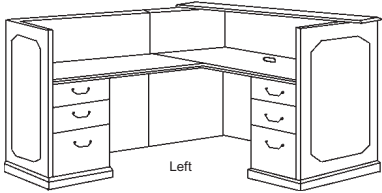

Hutches (H)

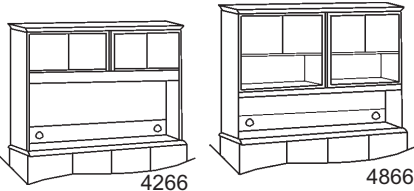

Work Tables (WT)

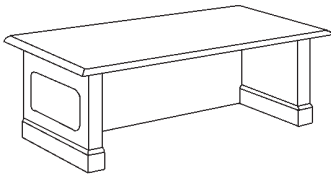

Lateral Files (LF)

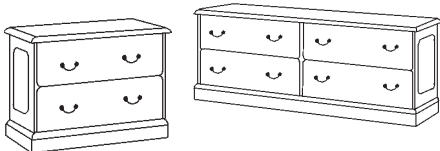

Vertical Files (VF)

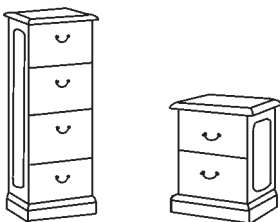

| Model Number | Depth | Width | Height | List | Weight | Cube |
|--|-------|-------|--------|---------|--------|------|
| CG-CU-3066-2236-3666 | 102 | 66 | 29 | \$3,318 | 520 | 102 |
| • CG-Dsp-3066 w/1 lock | 30 | 66 | 29 | \$1,344 | 215 | 40 |
| • CG-BR-2236-BC | 22 | 36 | 29 | \$630 | 100 | 15 |
| • CG-CCCsp-3666 | 36 | 66 | 29 | \$1,344 | 205 | 47 |
| CG-CU-3672-2236-3672 | 108 | 72 | 29 | \$3,546 | 575 | 117 |
| • CG-Dsp-3672 w/1 lock | 36 | 72 | 29 | \$1,418 | 225 | 51 |
| • CG-BR-2236-BC | 22 | 36 | 29 | \$630 | 100 | 15 |
| • CG-CCCsp-3672-LF w/1 lock | 36 | 72 | 29 | \$1,498 | 250 | 51 |
| See components for cutdowns | | | | | | |
| CG-Recep-3066-2448 | 78 | 66 | 43 | \$3,676 | 530 | 91 |
| • CG-Recep-3066 w/1 lock | 30 | 66 | 43 | \$2,490 | 380 | 57 |
| • CG-Recep-Ret-2448 | 25 | 48 | 43 | \$1,186 | 150 | 34 |
| CG-Recep-3072-2448 | 78 | 72 | 43 | \$3,938 | 570 | 108 |
| • CG-Recep-3072 w/1 lock | 30 | 72 | 43 | \$2,752 | 420 | 74 |
| • CG-Recep-Ret-2448 | 25 | 48 | 43 | \$1,186 | 150 | 34 |
| \$526 List to add 6" increments (\$264 List cut downs) | | | | | | |
| CG-H-4866 | 13 | 64 | 48 | \$978 | 150 | 32 |
| CG-H-4872 | 13 | 70 | 48 | \$1,072 | 160 | 35 |
| CG-H-4266 | 13 | 64 | 43 | \$756 | 130 | 29 |
| CG-H-4272 | 13 | 70 | 43 | \$862 | 140 | 31 |
| Half Laminate Doors Standard | | | | | | |
| CG-WT-2236 | 22 | 36 | 29 | \$578 | 65 | 15 |
| CG-WT-2448 | 24 | 48 | 29 | \$736 | 110 | 24 |
| CG-WT-2266 | 22 | 66 | 29 | \$862 | 105 | 27 |
| CG-WT-3066 | 30 | 66 | 29 | \$978 | 135 | 40 |
| CG-WT-2272 | 22 | 72 | 29 | \$946 | 115 | 30 |
| CG-WT-3672 | 36 | 72 | 29 | \$1,008 | 160 | 51 |
| \$264 List to add 6" increments (\$176 List cut downs) | | | | | | |
| CG-LF-2238-2D | 22 | 38 | 29 | \$930 | 170 | 16 |
| CG-LF-2272-4D | 22 | 72 | 29 | \$1,728 | 330 | 30 |
| Locks Standard | | | | | | |
| CG-VF-2422-2D | 24 | 22 | 29 | \$726 | 130 | 12 |
| CG-VF-2422-4D | 24 | 22 | 56 | \$1,344 | 280 | 22 |
| Locks Standard | | | | | | |

Sizes are nominal.

Congress Series

Laminate Traditional Styling, Adds Elegance in the Office.

How to Specify Left or Right Components

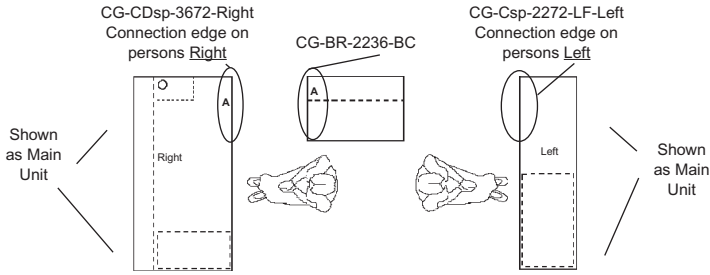

“Right” = Connects to Right side of main desk.

“Left” = Connects to Left side of main desk.

“A” = 22” Width

“B” = 24” Width

Components

Desk Tops

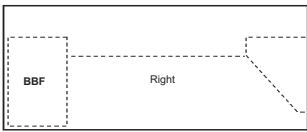

Computer Corners & Credenzas

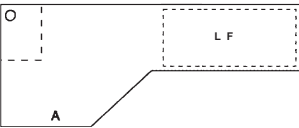
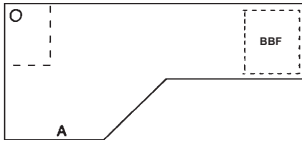

Returns-24” W/BBF Pedestals

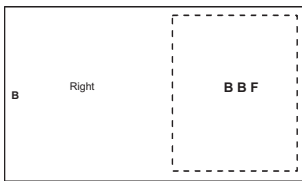

Rectangular Bridges W/Bookcase

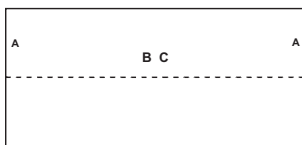

| Model Number | Depth | Width | Height | List | Weight | Cube |
|--|-------|-------|--------|---------|--------|------|
| CG-Dsp-3066 w/1 lock | 30 | 66 | 29 | \$1,344 | 215 | 40 |
| CG-Dsp-3672 w/1 lock | 36 | 72 | 29 | \$1,418 | 225 | 51 |
| \$264 List to add 6" increments (\$176 List cut downs) | | | | | | |
| CG-CCCsp-3666 | 36 | 66 | 29 | \$1,344 | 205 | 47 |
| CG-CCCsp-3672-LF w/1 lock | 36 | 72 | 29 | \$1,498 | 250 | 51 |
| CG-Csp-2266 | 22 | 66 | 29 | \$1,186 | 210 | 27 |
| CG-Csp-2272 | 22 | 72 | 29 | \$1,260 | 217 | 30 |
| CG-Csp-2266-Closed | 22 | 66 | 29 | \$1,344 | 230 | 27 |
| CG-Csp-2272-Closed | 22 | 72 | 29 | \$1,418 | 237 | 30 |
| \$350 List to add 6" increments (\$210 List cut downs) | | | | | | |
| CG-Ret-2448 | 24 | 48 | 29 | \$788 | 120 | 23 |
| CG-Ret-2460 | 24 | 60 | 29 | \$998 | 135 | 27 |
| \$264 List to add 6" increments (\$176 List cut downs) | | | | | | |
| CG-BR-2236-BC | 22 | 36 | 29 | \$630 | 100 | 15 |
| CG-BR-2448-BC | 24 | 47 | 29 | \$652 | 120 | 23 |
| \$264 List to add 6" increments (\$176 List cut downs) | | | | | | |

Sizes are nominal.

Congress Series

Laminate Traditional Styling, Adds Elegance in the Office.

Bookcases (BC)

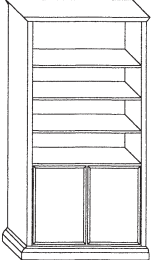

29" Lower Cabinet
Option Shown.

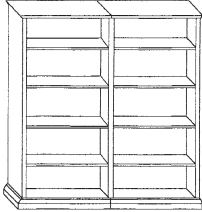

Multiple Bookcase Group
Option Shown.

Racetrack Conference Table (RACE)

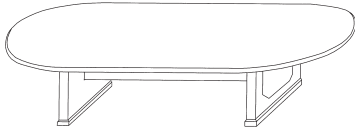

Boat-Shape Conference Table (BOAT)

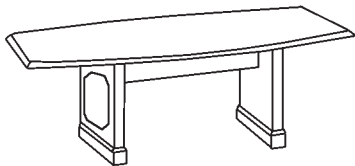

| Model Number | Depth | Width | Height | List | Weight | Cube |
|--|-------|-------|--------|---------|--------|------|
| CG-BC-2936-1 | 29 | 36 | 13 | \$484 | 70 | 10 |
| CG-BC-4834-2L For 2-D Lateral No Bottom | 12 | 34 | 48 | \$652 | 75 | 15 |
| CG-BC-4836-2 | 48 | 36 | 13 | \$652 | 85 | 16 |
| CG-BC-6036-3 | 60 | 36 | 13 | \$704 | 100 | 20 |
| CG-BC-7236-4 | 72 | 36 | 13 | \$726 | 115 | 23 |
| CG-BC-8436-5 | 84 | 36 | 13 | \$778 | 140 | 27 |
| CG-BC-3612-BKSLF Bookcase Shelf | 12 | 36 | .75 | \$62 | 4 | 1 |
| CG-BC-L-Cab 29" Lower Cabinet (72" & 84" only) | | | | \$348 | 15 | |
| Multiple Bookcase Groups Add Top Profile Reverses on 72" & 84" | | | | 10% | | |
| \$264 List cut downs | | | | | | |
| CG-3672-RACE | 36 | 72 | 29 | \$1,582 | 135 | 22 |
| • CG-3672-RACE-Top | 36 | 72 | 1.2 | \$1,324 | 85 | 6 |
| • CG-3672-REC-BOAT-Base | 25 | 31 | 29 | \$258 | 50 | 16 |
| CG-4896-RACE | 48 | 96 | 29 | \$1,788 | 198 | 37 |
| • CG-4896-RACE-Top | 48 | 96 | 1.2 | \$1,482 | 143 | 10 |
| • CG-4896-REC-BOAT-Base | 25 | 55 | 29 | \$306 | 55 | 27 |
| CG-48120-RACE | 48 | 120 | 29 | \$2,426 | 252 | 51 |
| • CG-48120-RACE-Top | 48 | 120 | 1.2 | \$2,058 | 177 | 12 |
| • CG-48120-REC-BOAT-Base | 25 | 81 | 29 | \$368 | 75 | 39 |
| CG-48144-RACE | 48 | 144 | 29 | \$3,288 | 312 | 66 |
| • CG-48144-RACE-Top | 48 | 144 | 1.2 | \$2,794 | 212 | 14 |
| • CG-48144-REC-BOAT-Base | 25 | 108 | 29 | \$494 | 100 | 52 |
| Top 2-Piece Base 2-Piece | | | | | | |
| \$526 List to add 12" increments (\$264 List cut downs) add 50% for 60" wide | | | | | | |
| CG-3672-BOAT | 36 | 72 | 29 | \$1,466 | 135 | 22 |
| • CG-3672-BOAT-Top | 36 | 72 | 1.2 | \$1,208 | 85 | 6 |
| • CG-3672-REC-BOAT-Base | 25 | 31 | 29 | \$258 | 50 | 16 |
| CG-4896-BOAT | 48 | 96 | 29 | \$1,588 | 198 | 37 |
| • CG-4896-BOAT-Top | 48 | 96 | 1.2 | \$1,282 | 143 | 10 |
| • CG-4896-REC-BOAT-Base | 25 | 55 | 29 | \$306 | 55 | 27 |
| CG-48120-BOAT | 48 | 120 | 29 | \$2,216 | 252 | 51 |
| • CG-48120-BOAT-Top | 48 | 120 | 1.2 | \$1,848 | 177 | 12 |
| • CG-48120-REC-BOAT-Base | 25 | 81 | 29 | \$368 | 75 | 39 |
| CG-48144-BOAT | 48 | 144 | 29 | \$3,068 | 312 | 66 |
| • CG-48144-BOAT-Top | 48 | 144 | 1.2 | \$2,574 | 212 | 14 |
| • CG-48144-REC-BOAT-Base | 25 | 108 | 29 | \$494 | 100 | 52 |
| Top 2-Piece Base 2-Piece | | | | | | |
| \$526 List to add 12" increments (\$264 List cut downs) add 50% for 60" wide | | | | | | |

Sizes are nominal.

Congress Series

Laminate Traditional Styling, Adds Elegance in the Office.

Rectangle Conference Table (REC)

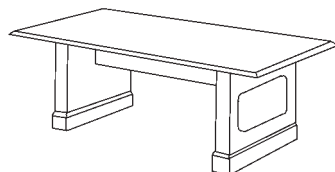

Round Conference Table (RND)

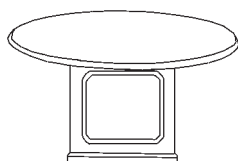

Conference Cabinet (CFC)

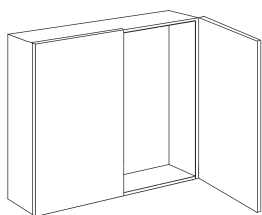

| Model Number | Depth | Width | Height | List | Weight | Cube |
|--|-------|-------|--------|---------|--------|------|
| CG-3672-REC | 36 | 72 | 29 | \$1,466 | 135 | 22 |
| • CG-3672-REC-Top | 36 | 72 | 1.2 | \$1,208 | 85 | 6 |
| • CG-3672-REC-BOAT-Base | 25 | 31 | 29 | \$258 | 50 | 16 |
| CG-4896-REC | 48 | 96 | 29 | \$1,588 | 198 | 37 |
| • CG-4896-REC-Top | 48 | 96 | 1.2 | \$1,282 | 143 | 10 |
| • CG-4896-REC-BOAT-Base | 25 | 55 | 29 | \$306 | 55 | 27 |
| CG-48120-REC | 48 | 120 | 29 | \$2,216 | 252 | 51 |
| • CG-48120-REC-Top | 48 | 120 | 1.2 | \$1,848 | 177 | 12 |
| • CG-48120-REC-BOAT-Base | 25 | 81 | 29 | \$368 | 75 | 39 |
| CG-48144-REC | 48 | 144 | 29 | \$3,068 | 312 | 66 |
| • CG-48144-REC-Top | 48 | 144 | 1.2 | \$2,574 | 212 | 14 |
| • CG-48144-REC-BOAT-Base | 25 | 108 | 29 | \$494 | 100 | 52 |
| Top 2-Piece Base 2-Piece | | | | | | |
| \$526 List to add 12" increments (\$264 List cut downs) add 50% for 60" wide | | | | | | |
| CG-42-RND | | 42 | 29 | \$1,178 | 118 | 17 |
| • CG-42-RND-Top | | 42 | 1.2 | \$842 | 62 | 4 |
| • CG-42-SQR-Base | | 42 | 29 | \$336 | 56 | 13 |
| CG-48-RND | | 48 | 29 | \$1,356 | 128 | 18 |
| • CG-48-RND-Top | | 48 | 1.2 | \$998 | 67 | 5 |
| • CG-48-SQR-Base | | 48 | 29 | \$358 | 61 | 13 |
| add 50% for 60" | | | | | | |
| 21-CFC-3636 | 5 | 36 | 36 | \$1,366 | 65 | 6 |
| 21-CFC-4848 | 5 | 48 | 48 | \$1,366 | 75 | 11 |
| | | | | | | |
| | | | | | | |
| | | | | | | |
| | | | | | | |
| | | | | | | |
| | | | | | | |
| | | | | | | |
| | | | | | | |
| | | | | | | |
| | | | | | | |
| | | | | | | |
| | | | | | | |
| | | | | | | |
| | | | | | | |
| | | | | | | |
| | | | | | | |
| | | | | | | |
| | | | | | | |
| | | | | | | |
| | | | | | | |
| | | | | | | |
| | | | | | | |
| | | | | | | |
| | | | | | | |
| | | | | | | |
| | | | | | | |
| | | | | | | |
| | | | | | | |
| | | | | | | |
| | | | | | | |
| | | | | | | |
| | | | | | | |

Sizes are nominal.

Congress Series

Laminate Traditional Styling, Adds Elegance in the Office.

OPTIONS:

Center Drawer Large

Center Drawer Small

**Convert Box/Box/File Ped to
File/File Ped**

| | Depth | Width | Height | List | Weight | Cube |
|---------------------|--------------|--------------|---------------|-------------|---------------|-------------|
| Model Number | | | | | | |
| Op-LAM-CD-Large | 20 | 26 | 3 | \$110 | 4 | 2 |
| Op-LAM-CD-Small | 20 | 20 | 3 | \$110 | 4 | 2 |
| Specify File/File | | | | N/C | | |
| | | | | | | |
| | | | | | | |
| | | | | | | |
| | | | | | | |
| | | | | | | |
| | | | | | | |
| | | | | | | |
| | | | | | | |
| | | | | | | |
| | | | | | | |
| | | | | | | |
| | | | | | | |
| | | | | | | |
| | | | | | | |
| | | | | | | |
| | | | | | | |
| | | | | | | |
| | | | | | | |
| | | | | | | |
| | | | | | | |

COLORS:

Mahogany

Touch-up Crayons (in all colors)

Touch-up Markers (in all colors)

| | | | | | | |
|---------------|--|--|--|------|--|--|
| LMA | | | | | | |
| Specify Color | | | | \$16 | | |
| Specify Color | | | | \$22 | | |
| | | | | | | |
| | | | | | | |
| | | | | | | |
| | | | | | | |
| | | | | | | |
| | | | | | | |
| | | | | | | |
| | | | | | | |
| | | | | | | |
| | | | | | | |
| | | | | | | |
| | | | | | | |
| | | | | | | |
| | | | | | | |
| | | | | | | |
| | | | | | | |
| | | | | | | |
| | | | | | | |
| | | | | | | |
| | | | | | | |
| | | | | | | |
| | | | | | | |

Sizes are nominal.

Congress Series

Laminate Traditional Styling, Adds Elegance in the Office.



| | Model Number | Description | List |
|------------------------|-------------------|--|-------|
| Grommet | Op-Grom | (Installed) Hardware, Grommet, 60mm Cable, Black | \$62 |
| | Op-Pwr-Grom | Retractable Power Grommet black | \$434 |
| Powered Grommet | Op-IL-RJ11-Cat. 3 | In-line data module, RJ 11Cat. 3 black | \$48 |
| | Op-IL-RJ45-Cat. 3 | In-line data module, RJ 45 Cat. 3 black | \$48 |
| | Op-HW-RJ11-Cat. 3 | Hard wire data module, RJ 11 Cat. 3 black | \$48 |
| | Op-HW-RJ45-Cat. 3 | Hard wire data module, RJ 45 Cat. 3 black | \$48 |
| | Op-HW-RJ45-Cat. 5 | Hard wire data module, RJ 45 Cat. 5 black | \$48 |
| | Op-HW-RJ45-Cat. 6 | Hard wire data module, RJ 45 Cat. 6 orange | \$82 |

Power Grommets Holds 1 or 2
Data Modules Only.

Grommet Placement Guide

When choosing an optional grommet, please use the drawings below to determine where you would like the grommet placed on the worksurface. For grommet placement in the modesty panels, place an "M" ahead of the number. Grommets through modesty panels are positioned at the highest possible point on the modesty panel.

For example: To have the grommet placed in the center of the modesty panel of a return, indicate "M1" on the order line for that item.

Please Note: Grommets cannot go through pedestals on 20" depth units.

Single Pedestal Right

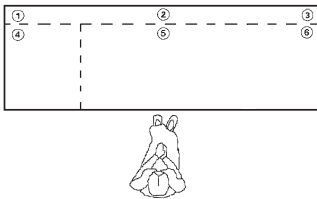

Single Pedestal Left

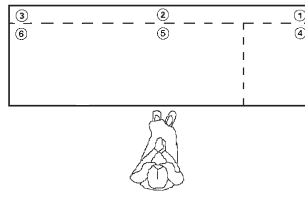

Double Pedestal

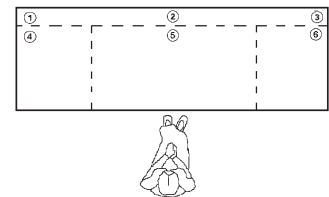

Computer Corner Credenzas

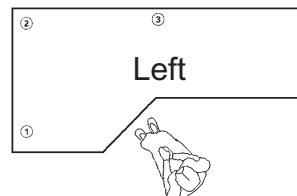
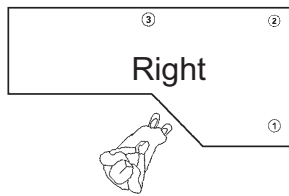

Credenzas

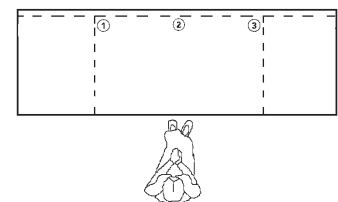

Return Right

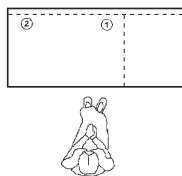

Return Left

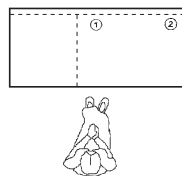

Conference Tables

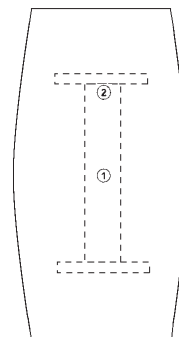

Bullet/P-tops

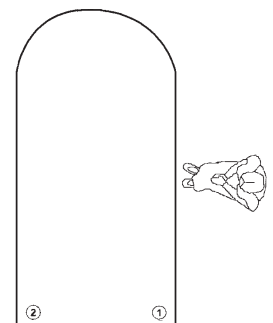

Computer Corner

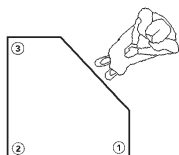

Bridges

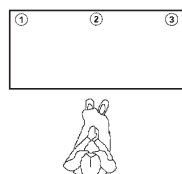

Congress Series

Laminate Traditional Styling, Adds Elegance in the Office.



Crescent Pull



Wire Pull



Button Pull



Tab Pull



Standard Pull



Traditional Pull



Congress

| Model Number | Description | Width | Height | Depth | List |
|--------------|--------------------------|-------|--------|-------|------|
| Op-B1 | Standard Pull Black | 278mm | 18mm | 10mm | \$38 |
| Op-N1 | Standard Pull Nickel | 278mm | 18mm | 10mm | \$38 |
| Op-B2 | Tab Pull Black | 40mm | 26mm | 8mm | \$38 |
| Op-N2 | Tab Pull Nickel | 40mm | 26mm | 8mm | \$38 |
| Op-B3 | Wire Pull Black | 153mm | 30mm | 10mm | \$38 |
| Op-N3 | Wire Pull Nickel | 153mm | 30mm | 10mm | \$38 |
| Op-B4 | Button Pull Black | 31mm | 28mm | 15mm | \$38 |
| Op-N4 | Button Pull Nickel | 31mm | 28mm | 15mm | \$38 |
| Op-B5 | Crescent Pull Black | 100mm | 24mm | 22mm | \$38 |
| Op-N5 | Crescent Pull Nickel | 100mm | 24mm | 22mm | \$38 |
| Op-A6 | Traditional Pull Antique | 147mm | 48mm | 14mm | \$38 |

HARDWARE:

| | Model Number | Depth | Width | Height | List | Weight | Cube |
|--|--|-------|-------|--------|-------|--------|------|
| Standard Keyboard Tray | KBT-Standard | 20 | 22 | 2 | \$118 | 10 | 2 |
| Standard Keyboard Tray With Mouse Tray | KBT-Standard-MT | 20 | 22 | 3 | \$196 | 10 | 2 |
| Keyboard Tray With Articulating Arm and Mouse Tray | KBT-ArtArm-MT | 20 | 27 | 4 | \$356 | 10 | 2 |
| Desk Lock | Op-DESK-LOCK | | | | \$62 | | |
| Casters | OP-Casters (add 2" to height) | | | 2 | \$128 | | |
| Cartoning | Corner guards, cardboard top, & sides (Priced per box) | | | | \$74 | | |
| | Bubble Wrap | | | | \$74 | | |
| | Bubble Wrap & Palletize | | | | \$126 | | |

Sizes are nominal.

NOTES

Office Series

Veneer

Hand Selected Veneer with an 8 Way Hardwood Radius Edge Boasts a Contemporary Design.

Standard Features:

- Full Suspension on all Drawers.
- Box/File Pedestals.
- 1/2" 9 Ply UV Coated Birch Drawer Material
- Touch Latch Doors on Credenzas.
- File Drawers Supplied with Rods for Hanging Legal and Letter Files.
- 20" Depth on Credenzas, Returns, Lateral Files, and Bridges.
- Matching Vertical Grain Drawer Fronts.
- Solid Hardwood 8 Way Edge.
- One Piece Vertical Grain Modesty Panels.
- Flush Height Returns.
- Adjustable Leveling Glides (except Bookcases).
- Hardwood Molding on Bottom of Side Panels
- Catalyzed Conversion Varnish Finish.
- Locks Keyed Alike.

8-Way Radius

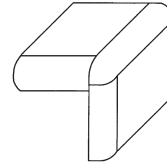

Desks - Double Pedestal/Single Pedestal/ Fan Top Desk (DP/SP/FDP)

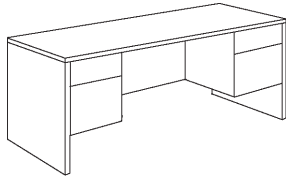

| Model Number | Depth | Width | Height | List | Weight | Cube |
|--|-------|-------|--------|---------|--------|------|
| OF-DP-3060 w/1 lock | 30 | 60 | 29 | \$1,292 | 285 | 36 |
| OF-DP-3066 w/1 lock | 30 | 66 | 29 | \$1,414 | 290 | 40 |
| OF-DP-3672 w/1 lock | 36 | 72 | 29 | \$1,526 | 310 | 51 |
| OF-SP-2448 w/1 lock | 24 | 48 | 29 | \$936 | 145 | 24 |
| \$264 List to add 6" increments (\$122 List cut downs) | | | | | | |
| OF-FDP-3066 w/1 lock | 36 | 66 | 29 | \$1,928 | 320 | 51 |
| OF-FDP-3672 w/1 lock | 42 | 72 | 29 | \$2,116 | 345 | 59 |
| \$350 List to add 6" increments (\$210 List cut downs) | | | | | | |
| OF-C-2060-Cab | 20 | 60 | 29 | \$1,292 | 233 | 25 |
| OF-C-2060-Open | 20 | 60 | 29 | \$1,292 | 215 | 25 |
| OF-C-2066-Cab | 20 | 66 | 29 | \$1,414 | 239 | 27 |
| OF-C-2066-Open | 20 | 66 | 29 | \$1,414 | 221 | 27 |
| OF-C-2072-Cab | 20 | 72 | 29 | \$1,526 | 245 | 30 |
| OF-C-2072-Open | 20 | 72 | 29 | \$1,526 | 227 | 30 |
| 24" Credenza depth add \$264 List | | | | | | |
| \$264 List to add 6" increments (\$122 List cut downs) | | | | | | |
| OF-DR-3060-2042 | 72 | 60 | 29 | \$1,982 | 305 | 54 |
| • OF-Dsp-3060 w/1 lock | 30 | 60 | 29 | \$1,224 | 210 | 36 |
| • OF-Ret-2042 | 20 | 42 | 29 | \$758 | 95 | 18 |
| OF-DR-3066-2447 | 77 | 66 | 29 | \$2,238 | 350 | 63 |
| • OF-Dsp-3066 w/1 lock | 30 | 66 | 29 | \$1,302 | 225 | 40 |
| • OF-Ret-2447 | 24 | 47 | 29 | \$936 | 125 | 23 |
| OF-DR-3672-2047 | 83 | 72 | 29 | \$2,462 | 335 | 71 |
| • OF-Dsp-3672 w/1 lock | 36 | 72 | 29 | \$1,526 | 235 | 51 |
| • OF-Ret-2047 | 20 | 47 | 29 | \$936 | 100 | 20 |
| OF-DR-3672-2447 | 83 | 72 | 29 | \$2,462 | 360 | 74 |
| • OF-Dsp-3672 w/1 lock | 36 | 72 | 29 | \$1,526 | 235 | 51 |
| • OF-Ret-2447 | 24 | 47 | 29 | \$936 | 125 | 23 |
| Fan & P-Top Available (See Components) | | | | | | |
| \$264 List to add 6" increments (\$122 List cut downs) | | | | | | |
| OF-Recep-3072-2447 | 77 | 72 | 43 | \$4,508 | 565 | 96 |
| • OF-Recep-3072-BF w/1 lock | 30 | 72 | 43 | \$2,706 | 400 | 62 |
| • OF-Recep-Ret-2447 | 24 | 47 | 43 | \$1,802 | 165 | 34 |
| \$526 List to add 6" increments (\$264 List cut downs) | | | | | | |

Credenzas (C-Open/C-Cab)

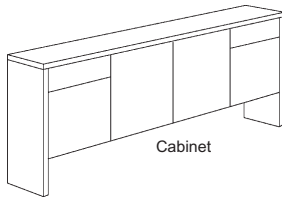

Cabinet

Desks with Return (DR)

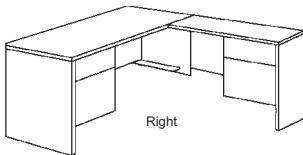

Right

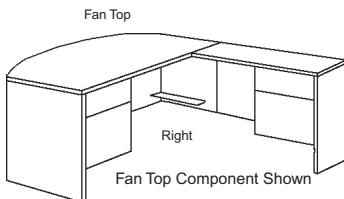

Fan Top

Right

Fan Top Component Shown

Reception Unit (Recep)

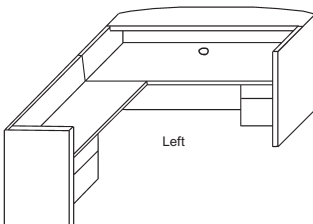

Left

Office

Sizes are nominal.

Office Series

Hand Selected Veneer with an 8 Way Hardwood Radius Edge Boasts a Contemporary Design.

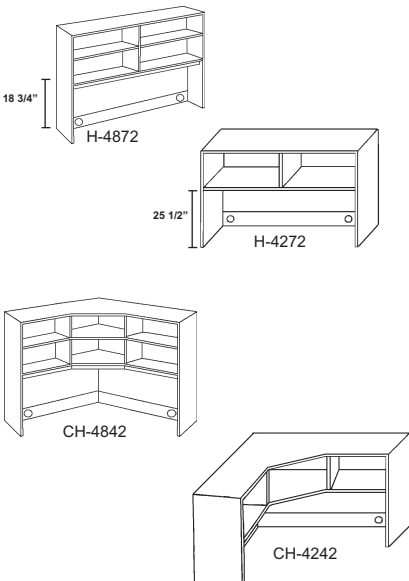
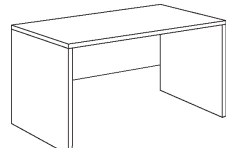
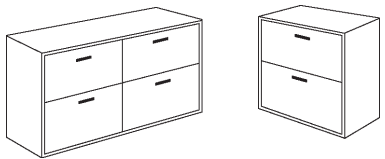
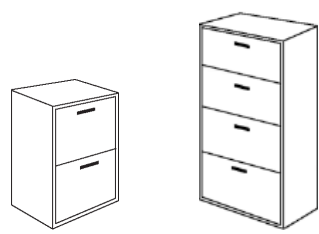
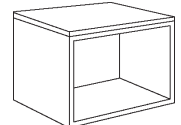
| | Model Number | Depth | Width | Height | List | Weight | Cube | |
|--|--|------------------------------|-------|--------|---------|---------|------|----|
| Hutches (H,CH,H-Filler,H-Organizer)  | OF-H-4845 | 14 | 45 | 48 | \$1,280 | 150 | 24 | |
| | OF-H-4857 | 14 | 57 | 48 | \$1,280 | 165 | 29 | |
| | OF-H-4863 | 14 | 63 | 48 | \$1,302 | 172 | 30 | |
| | OF-H-4869 | 14 | 69 | 48 | \$1,302 | 180 | 35 | |
| | OF-H-4245 | 14 | 45 | 43 | \$1,114 | 130 | 20 | |
| | OF-H-4257 | 14 | 57 | 43 | \$1,114 | 145 | 26 | |
| | OF-H-4263 | 14 | 63 | 43 | \$1,136 | 152 | 27 | |
| | OF-H-4269 | 14 | 69 | 43 | \$1,136 | 160 | 31 | |
| | OF-CH-4836 | 36 | 36 | 48 | \$1,646 | 165 | 42 | |
| | OF-CH-4842 | 42 | 42 | 48 | \$1,700 | 180 | 56 | |
| | OF-CH-4236 | 36 | 36 | 43 | \$1,376 | 145 | 37 | |
| | OF-CH-4242 | 42 | 42 | 43 | \$1,408 | 160 | 50 | |
| | 82-H-48-Filler (Fills space between hutches) | 1 | 4 | 48 | \$168 | 3 | 1 | |
| | 82-H-42-Filler | 1 | 4 | 42 | \$168 | 3 | 1 | |
| | OP-H-Organizer | 10 | 12 | 12 | \$168 | 4 | 1 | |
| Wood doors standard See options for door types | | | | | | | | |
| \$210 List cut downs (not available on corner hutch) | | | | | | | | |
| Work Tables (WT)  | OF-WT-2036 | 20 | 36 | 29 | \$546 | 70 | 15 | |
| | OF-WT-2042 | 20 | 42 | 29 | \$612 | 90 | 18 | |
| | OF-WT-2048 | 20 | 48 | 29 | \$612 | 105 | 20 | |
| | OF-WT-2060 | 20 | 60 | 29 | \$746 | 110 | 25 | |
| | OF-WT-2072 | 20 | 72 | 29 | \$890 | 125 | 30 | |
| | OF-WT-2448 | 24 | 48 | 29 | \$612 | 120 | 24 | |
| | OF-WT-3048 | 30 | 48 | 29 | \$724 | 140 | 29 | |
| | OF-WT-3060 | 30 | 60 | 29 | \$890 | 150 | 36 | |
| | OF-WT-3672 | 36 | 72 | 29 | \$1,136 | 170 | 51 | |
| | \$264 List to add 6" increments (\$122 List cut downs) | | | | | | | |
| | Lateral Files (LF)  | OF-LF-2038-2D w/handles (B1) | 20 | 38 | 29 | \$1,114 | 185 | 16 |
| | | OF-LF-2072-4D w/handles (B1) | 20 | 72 | 29 | \$1,818 | 345 | 30 |
| Locks Standard | | | | | | | | |
| Vertical Files (VF)  | OF-VF-2423-2D w/handles (B1) | 24 | 23 | 29 | \$968 | 130 | 12 | |
| | OF-VF-2423-4D w/handles (B1) | 24 | 23 | 54 | \$1,426 | 260 | 21 | |
| | OF-VLF-2038-4D w/handles (B1) | 20 | 38 | 54 | \$2,002 | 345 | 30 | |
| | Locks Standard | | | | | | | |
| Occasional Tables (OT)  | OF-OT-2020 | 20 | 20 | 20 | \$446 | 45 | 7 | |
| | OF-OT-2048 | 20 | 48 | 20 | \$624 | 70 | 15 | |
| | \$264 List to add 6" increments (\$122 List cut downs) | | | | | | | |

Sizes are nominal.

Office Series

Hand Selected Veneer with an 8 Way Hardwood Radius Edge Boasts a Contemporary Design.

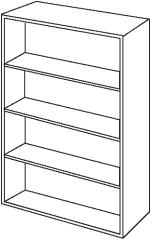
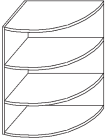
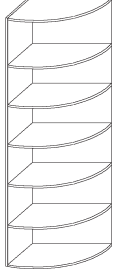
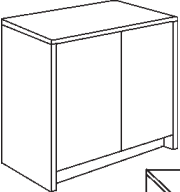
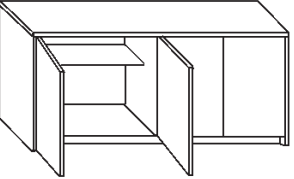
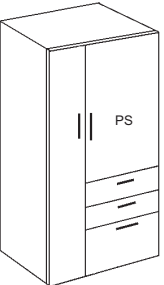
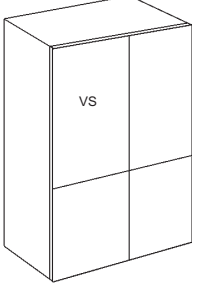
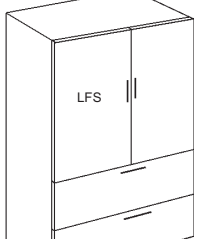
| | Model Number | Depth | Width | Height | List | Weight | Cube |
|---|---|----------------------|-------|--------|---------|--------|------|
| Bookcases (BC)  | OF-BC-2936-1 | 12 | 36 | 29 | \$396 | 70 | 10 |
| | OF-BC-4834-2L For 2-D Lateral No Bottom | 14 | 34 | 48 | \$524 | 75 | 15 |
| | OF-BC-4836-2 | 12 | 36 | 48 | \$524 | 85 | 16 |
| | OF-BC-6036-3 | 12 | 36 | 60 | \$668 | 100 | 20 |
| | OF-BC-7236-4 | 12 | 36 | 72 | \$824 | 115 | 23 |
| | OF-BC-8436-5 | 12 | 36 | 84 | \$924 | 140 | 27 |
| | OF-BC-3612-BKSLF Bookcase Shelf | 12 | 36 | .75 | \$62 | 4 | 1 |
| | OF-BC-L-Cab 29" Lower Cabinet (72" & 84" only) | | | | \$296 | 15 | |
| | | \$210 List cut downs | | | | | |
| | Corner Bookcases / Corner Bookcase Hutch (CBC / CBCH)   | OF-CBC-2029-1 | 20 | 20 | 29 | \$662 | 70 |
| OF-CBC-2072-4 | | 20 | 20 | 72 | \$1,082 | 115 | 21 |
| OF-CBCH-1448 | | 14 | 14 | 48 | \$792 | 70 | 8 |
| OF-CBCH-1442 | | 14 | 14 | 43 | \$792 | 65 | 7 |
| | | | | | | | |
| Storage Cabinets (SC)   | OF-SC-2019 | 20 | 19 | 29 | \$758 | 110 | 8 |
| | OF-SC-2032 | 20 | 32 | 29 | \$1,002 | 120 | 13 |
| | OF-SC-2038 | 20 | 38 | 29 | \$1,080 | 130 | 15 |
| | | | | | | | |
| | OF-SC-2060 | 20 | 60 | 29 | \$1,480 | 155 | 25 |
| | OF-SC-2072 | 20 | 72 | 29 | \$1,726 | 165 | 30 |
| Storage - Vertical / Personal / Lateral File (VS/PS/LFS)    | OF-VS-3872 Door Locks Optional | 20 | 38 | 72 | \$1,712 | 330 | 38 |
| | | | | | | | |
| | OF-PS-3072 Door Locks Optional (BBF cannot lock) Specify right or left (right shown) w/handles (B1) | 20 | 30 | 72 | \$2,618 | 340 | 30 |
| | | | | | | | |
| | OF-LFS-3872 W/1 lock on LAT Door Locks Optional w/handles (B1) | 20 | 38 | 72 | \$2,332 | 350 | 38 |

Office

Sizes are nominal.

Office Series

Hand Selected Veneer with an 8 Way Hardwood Radius Edge Boasts a Contemporary Design.

Computer U-Shape Desks (CU)

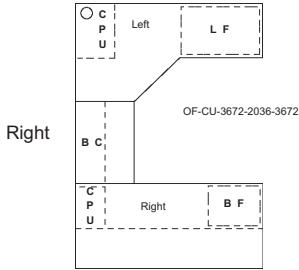

U-Shape Desks (NCU)

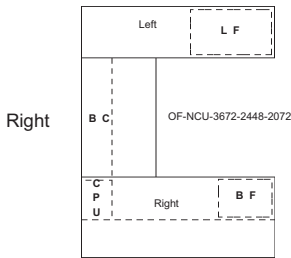

Bullet Computer U-Shape Desks (BCU)

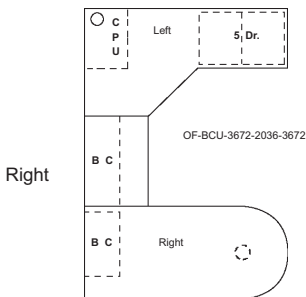

Bullet U-Shape Desks (BNCU)

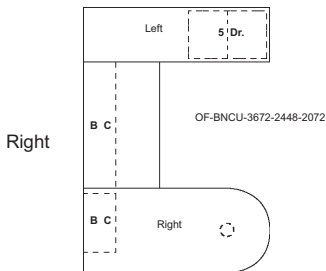

Computer Corner with Return (CR)

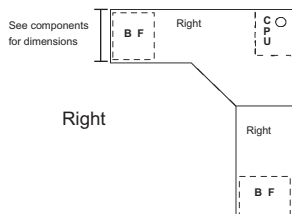

| Model Number | Depth | Width | Height | List | Weight | Cube |
|------------------------------|-------|-------|--------|---------|--------|------|
| OF-CU-3066-2036-3666 | 102 | 66 | 29 | \$4,174 | 545 | 102 |
| • OF-Dsp-3066 w/1 lock | 30 | 66 | 29 | \$1,302 | 225 | 40 |
| • OF-BR-2036-BC | 20 | 36 | 29 | \$758 | 105 | 15 |
| • OF-CCCsp-3666 | 36 | 66 | 29 | \$2,114 | 215 | 47 |
| OF-CU-3672-2036-3672 | 108 | 72 | 29 | \$4,482 | 605 | 117 |
| • OF-Dsp-3672 w/1 lock | 36 | 72 | 29 | \$1,526 | 235 | 51 |
| • OF-BR-2036-BC | 20 | 36 | 29 | \$758 | 105 | 15 |
| • OF-CCCsp-3672-LF w/1 lock | 36 | 72 | 29 | \$2,198 | 265 | 51 |
| w/handles (B1) | | | | | | |
| See Components for cut downs | | | | | | |
| OF-NCU-3672-2448-2072 | 103 | 72 | 29 | \$4,170 | 575 | 104 |
| • OF-Dsp-3672 w/1 lock | 36 | 72 | 29 | \$1,526 | 235 | 51 |
| • OF-BR-2447-BC | 24 | 47 | 29 | \$1,086 | 125 | 23 |
| • OF-Csp-2072-LF w/1 lock | 20 | 72 | 29 | \$1,558 | 215 | 30 |
| w/handles (B1) | | | | | | |
| See Components for cut downs | | | | | | |
| OF-BCU-3672-2036-3672 | 108 | 72 | 29 | \$4,820 | 520 | 117 |
| • OF-B-3672 | 36 | 72 | 29 | \$1,836 | 150 | 51 |
| • OF-BR-2036-BC | 20 | 36 | 29 | \$758 | 105 | 15 |
| • OF-CCCsp-3672-5DR | 36 | 72 | 29 | \$2,226 | 265 | 51 |
| w/handles (B1) | | | | | | |
| Cylinder MOD Optional | | | | | | |
| OF-BCU-3684-2036-3672 | 108 | 84 | 29 | \$4,932 | 535 | 125 |
| • OF-B-3684 | 36 | 84 | 29 | \$1,948 | 165 | 59 |
| • OF-BR-2036-BC | 20 | 36 | 29 | \$758 | 105 | 15 |
| • OF-CCCsp-3672-5DR | 36 | 72 | 29 | \$2,226 | 265 | 51 |
| w/handles (B1) | | | | | | |
| Cylinder MOD Optional | | | | | | |
| See Components for cut downs | | | | | | |
| OF-BNCU-3672-2448-2072 | 103 | 72 | 29 | \$4,480 | 490 | 104 |
| • OF-B-3672 | 36 | 72 | 29 | \$1,836 | 150 | 51 |
| • OF-BR-2447-BC | 24 | 47 | 29 | \$1,086 | 125 | 23 |
| • OF-Csp-2072-5DR | 20 | 72 | 29 | \$1,558 | 215 | 30 |
| w/handles (B1) | | | | | | |
| Cylinder MOD Optional | | | | | | |
| See Components for cut downs | | | | | | |
| OF-CR-3666-2042 | 78 | 66 | 29 | \$2,872 | 310 | 65 |
| • OF-CCCsp-3666 | 36 | 66 | 29 | \$2,114 | 215 | 47 |
| • OF-Ret-2042 | 20 | 42 | 29 | \$758 | 95 | 18 |
| OF-CR-3672-2448 | 83 | 72 | 29 | \$2,996 | 350 | 74 |
| • OF-CCDsp-3672 | 36 | 72 | 29 | \$2,060 | 225 | 51 |
| • OF-Ret-2447 | 24 | 47 | 29 | \$936 | 125 | 23 |
| See Components for cut downs | | | | | | |

Sizes are nominal.

Office Series

Hand Selected Veneer with an 8 Way Hardwood Radius Edge Boasts a Contemporary Design.

How to Specify Left or Right Components

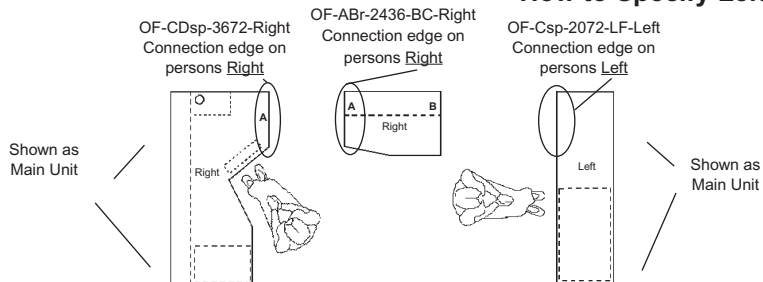

“Right” = Connects to Right side of main desk.

“Left” = Connects to Left side of main desk.

“A” = 20” Width

“B” = 24” Width

Components

Desk Tops

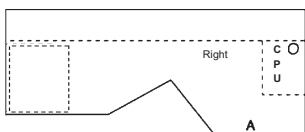
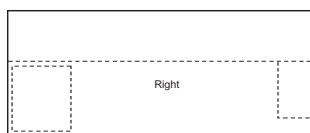

Fan Tops

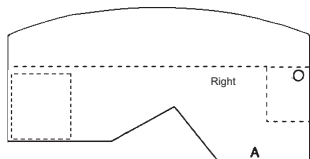
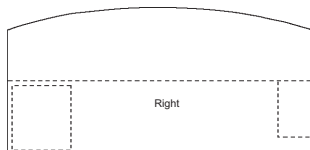

Bullet Tops

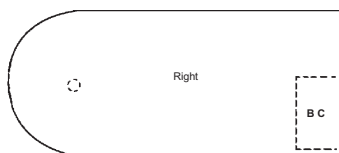

Computer Bullet Tops

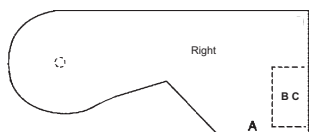

P-Tops

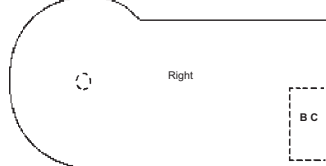

| Model Number | Depth | Width | Height | List | Weight | Cube |
|--|-------|-------|--------|---------|--------|------|
| OF-Dsp-3060 w/1 lock | 30 | 60 | 29 | \$1,224 | 210 | 36 |
| OF-Dsp-3066 w/1 lock | 30 | 66 | 29 | \$1,302 | 225 | 40 |
| OF-Dsp-3672 w/1 lock | 36 | 72 | 29 | \$1,526 | 235 | 51 |
| \$264 List to add 6" increments (\$122 List cut downs) | | | | | | |
| OF-CDsp-3672 w/1 lock | 36 | 72 | 29 | \$1,896 | 225 | 51 |
| \$350 List to add 6" increments (\$210 List cut downs) | | | | | | |
| OF-FDsp-3066 w/1 lock | 36 | 66 | 29 | \$1,878 | 260 | 51 |
| OF-FDsp-3672 w/1 lock | 42 | 72 | 29 | \$2,114 | 270 | 59 |
| \$350 List to add 6" increments (\$210 List cut downs) | | | | | | |
| OF-FCDsp-3672 w/1 lock | 42 | 72 | 29 | \$2,392 | 265 | 59 |
| \$350 List to add 6" increments (\$210 List cut downs) | | | | | | |
| OF-B-3672 | 36 | 72 | 29 | \$1,836 | 150 | 51 |
| OF-B-3684 | 36 | 84 | 29 | \$1,948 | 165 | 59 |
| Cylinder MOD Optional | | | | | | |
| \$350 List to add 6" increments (\$210 List cut downs) | | | | | | |
| OF-CB-3672 | 36 | 72 | 29 | \$2,112 | 145 | 51 |
| OF-CB-3684 | 36 | 84 | 29 | \$2,224 | 155 | 59 |
| Cylinder MOD Optional | | | | | | |
| \$350 List to add 6" increments (\$210 List cut downs) | | | | | | |
| OF-P-3672 | 42 | 72 | 29 | \$1,836 | 190 | 59 |
| Cylinder MOD Optional | | | | | | |
| \$350 List to add 6" increments (\$210 List cut downs) | | | | | | |

Sizes are nominal.

Office Series

Hand Selected Veneer with an 8 Way Hardwood Radius Edge Boasts a Contemporary Design.

P-Tops

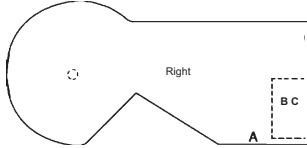

Computer Corners & Credenzas

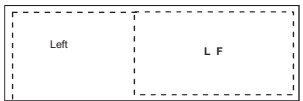
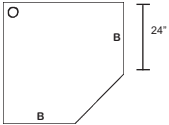
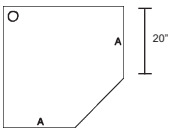
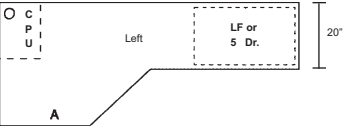
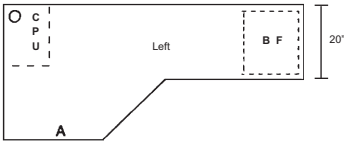
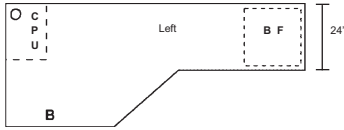

| Model Number | Depth | Width | Height | List | Weight | Cube |
|--|-------|-------|--------|---------|--------|------|
| OF-CP-3672 Cylinder MOD Optional | 48 | 72 | 29 | \$2,324 | 170 | 67 |
| OF-CCDsp-3672-BF | 36 | 72 | 29 | \$2,060 | 225 | 51 |
| OF-CCCsp-3666-BF | 36 | 66 | 29 | \$2,114 | 215 | 47 |
| OF-CCCsp-3672-LF w/1 lock w/handles (B1) | 36 | 72 | 29 | \$2,198 | 265 | 51 |
| OF-CCCsp-3672-5DR w/handles (B1) | 36 | 72 | 29 | \$2,226 | 265 | 51 |
| \$350 List to add 6" increments (\$210 List cut downs) | | | | | | |
| OF-CC-3636-20 | 36 | 36 | 29 | \$948 | 135 | 26 |
| OF-CC-4242-20 | 42 | 42 | 29 | \$1,100 | 175 | 35 |
| OF-CC-3636-24 | 36 | 36 | 29 | \$948 | 135 | 26 |
| OF-CC-4242-24 | 42 | 42 | 29 | \$1,100 | 175 | 35 |
| OF-Csp-2060 | 20 | 60 | 29 | \$1,224 | 175 | 25 |
| OF-Csp-2072 | 20 | 72 | 29 | \$1,526 | 195 | 30 |
| OF-Csp-2060-LF w/1 lock w/handles (B1) | 20 | 60 | 29 | \$1,390 | 205 | 25 |
| OF-Csp-2072-LF w/1 lock w/handles (B1) | 20 | 72 | 29 | \$1,558 | 215 | 30 |
| OF-Csp-2072-5DR w/handles (B1) | 20 | 72 | 29 | \$1,558 | 215 | 30 |
| \$264 List to add 6" increments (\$122 List cut downs) | | | | | | |

Sizes are nominal.

Office Series

Hand Selected Veneer with an 8 Way Hardwood Radius Edge Boasts a Contemporary Design.

Returns-20" W/BF Pedestals

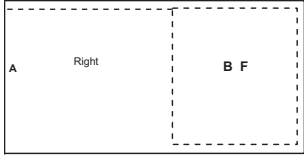

Returns-24" W/BF Pedestals

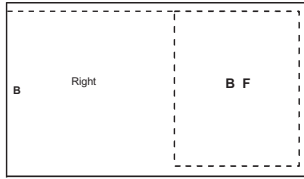

Rectangular Bridges W/Bookcase

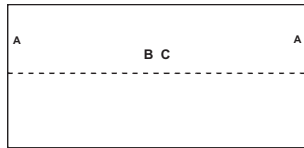

Angled Returns-24" W/BF Pedestals

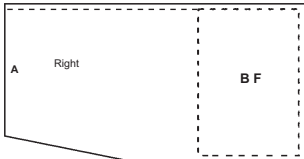

Angled Bridge-24" W/Bookcase

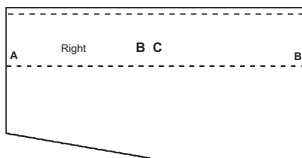

| Model Number | Depth | Width | Height | List | Weight | Cube |
|--|-------|-------|--------|---------|--------|------|
| OF-Ret-2042-BF | 20 | 42 | 29 | \$758 | 95 | 18 |
| OF-Ret-2047-BF | 20 | 47 | 29 | \$936 | 100 | 20 |
| \$264 List to add 6" increments (\$122 List cut downs) | | | | | | |
| OF-Ret-2436 | 24 | 36 | 29 | \$806 | 105 | 18 |
| OF-Ret-2447 | 24 | 47 | 29 | \$936 | 125 | 23 |
| \$264 List to add 6" increments (\$122 List cut downs) | | | | | | |
| OF-BR-2036-BC | 20 | 36 | 29 | \$758 | 105 | 15 |
| OF-BR-2447-BC | 24 | 47 | 29 | \$1,086 | 125 | 23 |
| \$264 List to add 6" increments (\$122 List cut downs) | | | | | | |
| OF-ARet-2436 | 24 | 36 | 29 | \$916 | 100 | 18 |
| OF-ARet-2447 | 24 | 47 | 29 | \$1,046 | 115 | 23 |
| \$264 List to add 6" increments (\$176 List cut downs) | | | | | | |
| OF-ABr-2436-BC | 24 | 36 | 29 | \$1,068 | 110 | 18 |
| OF-ABr-2447-BC | 24 | 47 | 29 | \$1,196 | 120 | 23 |
| \$264 List to add 6" increments (\$176 List cut downs) | | | | | | |

Office

Sizes are nominal.

Office Series

Hand Selected Veneer with an 8 Way Hardwood Radius Edge Boasts a Contemporary Design.

Conference Table Top Edge Details

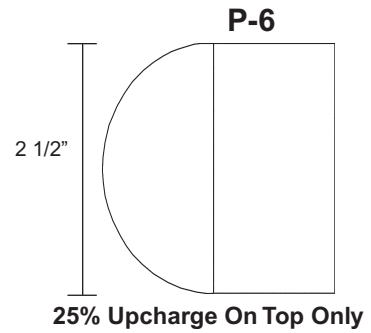
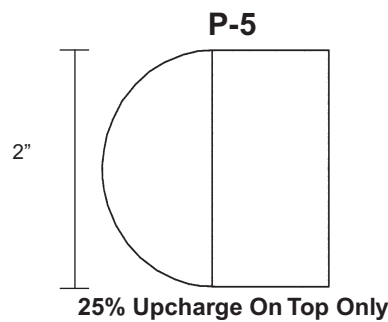
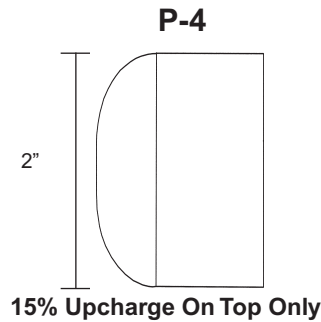
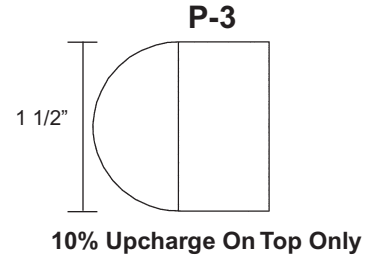
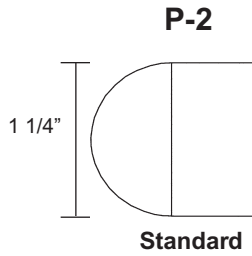
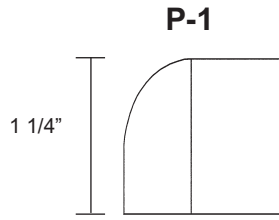

Racetrack Conference Table (RACE)

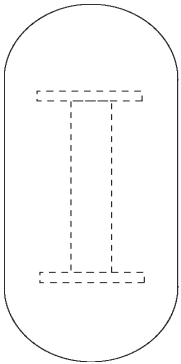

| Model Number | Depth | Width | Height | List | Weight | Cube |
|--|-------|-------|--------|---------|--------|------|
| OF-3672-Race | 36 | 72 | 29 | \$2,344 | 135 | 22 |
| • OF-3672-Race-TOP | 36 | 72 | 1.2 | \$1,954 | 85 | 6 |
| • OF-3672-Rec-Boat-BASE | 24 | 31 | 29 | \$390 | 50 | 16 |
| OF-4896-Race | 48 | 96 | 29 | \$2,734 | 198 | 37 |
| • OF-4896-Race-TOP | 48 | 96 | 1.2 | \$2,246 | 143 | 10 |
| • OF-4896-Rec-Boat-BASE | 24 | 55 | 29 | \$488 | 55 | 27 |
| OF-48120-Race | 48 | 120 | 29 | \$3,380 | 252 | 51 |
| • OF-48120-Race-TOP | 48 | 120 | 1.2 | \$2,730 | 177 | 12 |
| • OF-48120-Rec-Boat-BASE | 24 | 81 | 29 | \$650 | 75 | 39 |
| OF-48144-Race | 48 | 144 | 29 | \$4,414 | 312 | 66 |
| • OF-48144-Race-TOP | 48 | 144 | 1.2 | \$3,506 | 212 | 14 |
| • OF-48144-Rec-Boat-BASE | 24 | 108 | 29 | \$908 | 100 | 52 |
| Top 2-Piece Base 2-Piece | | | | | | |
| \$526 List to add 12" increments (\$210 List cut downs) add 50% for 60" wide | | | | | | |
| OF-36-RND | 36 | 36 | 29 | \$1,178 | 100 | 16 |
| • OF-36-RND-TOP | 36 | 36 | 1.2 | \$856 | 62 | 3 |
| • 82-X-Base | 24 | 24 | 29 | \$322 | 38 | 13 |
| OF-42-RND | 42 | 42 | 29 | \$1,288 | 118 | 17 |
| • OF-42-RND-TOP | 42 | 42 | 1.2 | \$966 | 80 | 4 |
| • 82-X-Base | 24 | 24 | 29 | \$322 | 38 | 13 |
| OF-48-RND | 48 | 48 | 29 | \$1,288 | 128 | 18 |
| • OF-48-RND-TOP | 48 | 48 | 1.2 | \$966 | 90 | 5 |
| • 82-X-Base | 24 | 24 | 29 | \$322 | 38 | 13 |
| add 50% for 60" | | | | | | |

Round Conference Table (RND)

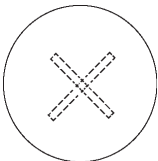

Sizes are nominal.

Office Series

Hand Selected Veneer with an 8 Way Hardwood Radius Edge Boasts a Contemporary Design.

Boat Shape Conference Table (BOAT)

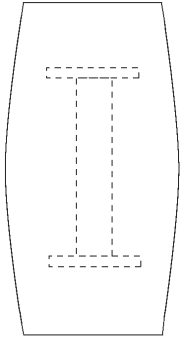

| Model Number | Depth | Width | Height | List | Weight | Cube |
|--|-------|-------|--------|---------|--------|------|
| OF-3672-Boat | 36 | 72 | 29 | \$1,560 | 135 | 22 |
| • OF-3672-Boat-TOP | 36 | 72 | 1.2 | \$1,170 | 85 | 6 |
| • OF-3672-Rec-Boat-BASE | 24 | 31 | 29 | \$390 | 50 | 16 |
| OF-4896-Boat | 48 | 96 | 29 | \$1,954 | 198 | 37 |
| • OF-4896-Boat-TOP | 48 | 96 | 1.2 | \$1,466 | 143 | 10 |
| • OF-4896-Rec-Boat-BASE | 24 | 55 | 29 | \$488 | 55 | 27 |
| OF-48120-Boat | 48 | 120 | 29 | \$2,598 | 252 | 51 |
| • OF-48120-Boat-TOP | 48 | 120 | 1.2 | \$1,948 | 177 | 12 |
| • OF-48120-Rec-Boat-BASE | 24 | 81 | 29 | \$650 | 75 | 39 |
| OF-48144-Boat | 48 | 144 | 29 | \$3,634 | 312 | 66 |
| • OF-48144-Boat-TOP | 48 | 144 | 1.2 | \$2,726 | 212 | 14 |
| • OF-48144-Rec-Boat-Base | 24 | 108 | 29 | \$908 | 100 | 52 |
| Top 2-Piece Base 2-Piece | | | | | | |
| \$526 List to add 12" increments (\$210 List cut downs) add 50% for 60" wide | | | | | | |

Rectangle Conference Table (REC)

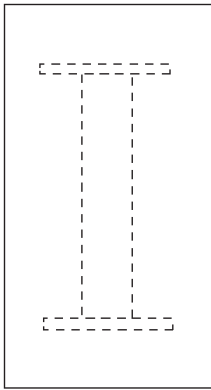

| | | | | | | |
|--|----|-----|-----|---------|-----|----|
| OF-3672-Rec | 36 | 72 | 29 | \$1,560 | 135 | 22 |
| • OF-3672-Rec-TOP | 36 | 72 | 1.2 | \$1,170 | 85 | 6 |
| • OF-3672-Rec-Boat-BASE | 24 | 31 | 29 | \$390 | 50 | 16 |
| OF-4896-Rec | 48 | 96 | 29 | \$1,954 | 198 | 37 |
| • OF-4896-Rec-TOP | 48 | 96 | 1.2 | \$1,466 | 143 | 10 |
| • OF-4896-Rec-Boat-BASE | 24 | 55 | 29 | \$488 | 55 | 27 |
| OF-48120-Rec | 48 | 120 | 29 | \$2,598 | 252 | 51 |
| • OF-48120-Rec-TOP | 48 | 120 | 1.2 | \$1,948 | 177 | 12 |
| • OF-48120-Rec-Boat-BASE | 24 | 81 | 29 | \$650 | 75 | 39 |
| OF-48144-Rec | 48 | 144 | 29 | \$3,634 | 312 | 66 |
| • OF-48144-Rec-TOP | 48 | 144 | 1.2 | \$2,726 | 212 | 14 |
| • OF-48144-Rec-Boat-Base | 24 | 108 | 29 | \$908 | 100 | 52 |
| Top 2-Piece Base 2-Piece | | | | | | |
| \$526 List to add 12" increments (\$210 List cut downs) add 50% for 60" wide | | | | | | |

Conference Cabinets (CFC)

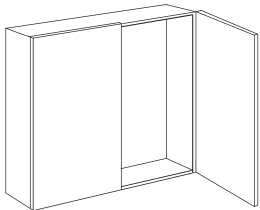

| | | | | | | |
|-------------|---|----|----|---------|----|----|
| 82-CFC-3636 | 5 | 36 | 36 | \$1,764 | 65 | 6 |
| 82-CFC-4848 | 5 | 48 | 48 | \$1,764 | 75 | 11 |
| | | | | | | |
| | | | | | | |
| | | | | | | |
| | | | | | | |
| | | | | | | |
| | | | | | | |
| | | | | | | |
| | | | | | | |

Lectern (LT)

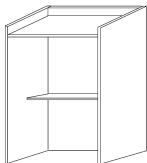

| | | | | | | |
|------------|----|----|----|---------|-----|----|
| 82-LT-2030 | 20 | 30 | 46 | \$1,198 | 105 | 15 |
| | | | | | | |
| | | | | | | |
| | | | | | | |
| | | | | | | |

Sizes are nominal.

Office Series

Hand Selected Veneer with an 8 Way Hardwood Radius Edge Boasts a Contemporary Design.

Cylinder Bases

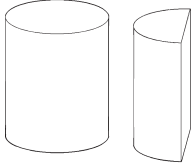

Wall Hanging Overhead (OH)

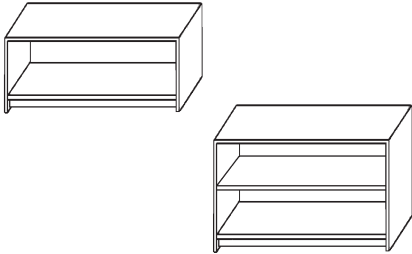

Stand Alone Pedestals (PED)

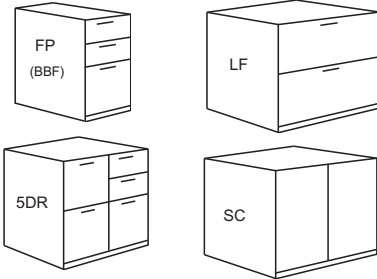

Built in Printer and CPU Pullouts (PPO, CPU)

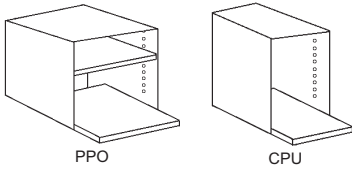

Built in Pedestals (PED)

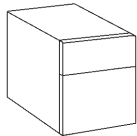

| Model Number | Depth | Width | Height | List | Weight | Cube |
|---|-------|-------|--------|---------|--------|------|
| • 82-Cylinder BASE | 18 | 18 | 27 | \$488 | 25 | 10 |
| • 82-1/2 Cylinder BASE | 18 | 9 | 27 | \$488 | 18 | 6 |
| All Tables w/ Cylinder Base, Must Be Ordered in Components Pieces | | | | | | |
| add 50% for 30" | | | | | | |
| 82-OH-1634 | 14 | 34 | 16 | \$652 | 70 | 7 |
| 82-OH-3034 | 14 | 34 | 28 | \$820 | 130 | 11 |
| Doors not standard See options for door configurations | | | | | | |
| 82-PED-2017-BBF-FF-SA | 19 | 17 | 27 | \$634 | 45 | 7 |
| Specify - Box/Box/File or File/File | | | | | | |
| 82-PED-2036-LF-SA | 19 | 36 | 27 | \$1,114 | 65 | 14 |
| w/handles (B1) | | | | | | |
| 82-PED-2033-5DR-SA | 19 | 33 | 27 | \$1,222 | 70 | 13 |
| w/handles (B1) | | | | | | |
| 82-PED-2036-SC-SA | 19 | 36 | 27 | \$1,114 | 65 | 14 |
| Note - Peds have unfinished backs | | | | | | |
| See hardware for casters | | | | | | |
| Adding casters will make unit 29 high | | | | | | |
| 82-PPO-20 | 19 | 22 | 24 | \$568 | 15 | |
| 82-CPU-PO-20 | 19 | 12 | 24 | \$430 | 10 | |
| 20" depth units only | | | | | | |
| 82-PPO-24 | 23 | 22 | 24 | \$568 | 17 | |
| 82-CPU-PO-24 | 23 | 12 | 24 | \$430 | 12 | |
| 24", 30", 36" depth units only | | | | | | |
| Must be added to no ped, full ped, or lat file units only | | | | | | |
| Doors not standard See options for doors | | | | | | |
| 82-PED-2017-BF-BI add ped | 19 | 17 | 18 | \$294 | 30 | |
| remove ped | | | | -\$176 | -30 | |
| 82-PED-2036-LF-BI add ped | 19 | 36 | 27 | \$776 | 65 | |
| 82-PED-2032-5DR-BI add ped | 19 | 33 | 24 | \$958 | 70 | |
| Space Limitations Apply | | | | | | |
| See Options for full ped upcharge | | | | | | |

Sizes are nominal.

Office Series

Hand Selected Veneer with an 8 Way Hardwood Radius Edge Boasts a Contemporary Design.

| | Model Number | Depth | Width | Height | List | Weight | Cube |
|--|---|-------|-------|--------|---------------------|--------|------|
| OPTIONS: | | | | | | | |
| Center Drawer Large | Op-WD-CD-Large | 20 | 24 | 3 | \$110 | 4 | 2 |
| Center Drawer Small | Op-WD-CD-Small | 20 | 20 | 3 | \$110 | 4 | 2 |
| Full Pedestal With Lock File File Configuration Or Box Box File Configuration (Includes Full Modesty) | Op-FULL PED | | | | \$246 | 225 | |
| 1/2 Cylinder Base with Full Modesty Panel | Op-Cylinder MOD | | | | \$488 | 40 | |
| Hutch Doors | 21-H-Full Glass Doors | 1 | | 26 | \$856 | 20 | |
| | 21-CH-Full Glass Doors | 1 | | 26 | \$856 | 20 | |
| | 21-H-Upper Half Glass Doors | 1 | | 13 | \$708 | 10 | |
| | 21-CH-Upper Half Glass Doors | 1 | | 13 | \$708 | 10 | |
| Printer and CPU Doors | 21-CPU-Door | 1 | 12 | 24 | \$110 | 3 | |
| | 21-PPO-Door | 1 | 21 | 24 | \$110 | 4 | |
| Overhead Doors | Op-OH-Doors | 1 | | 13 | \$142 | 5 | |
| Full Modesty Panel | Op-FULL MOD | | | | \$78 | 10 | |
| COLORS: | | | | | | | |
| Light Oak | WLO | | | | | | |
| Medium Oak | WMO | | | | | | |
| Natural Oak | WNO | | | | | | |
| Mahogany on Maple | WMA | | | | | | |
| Light Cherry on Maple | WLC | | | | | | |
| Medium Cherry on Maple | WMC | | | | | | |
| Natural Maple | WNM | | | | | | |
| Mahogany on Cherry | WPM-Mahogany on Cherry | | | | 10% | | |
| Light Cherry on Cherry | WPL-Light Cherry on Cherry | | | | 10% | | |
| Medium Cherry on Cherry | WPC-Medium Cherry on Cherry | | | | 10% | | |
| Walnut on Cherry | WWC-Walnut on Cherry | | | | 10% | | |
| High Pressure Tops | Includes choice from most colors by: Formica, Nevamar, Pionite, & Wilsonart | | | | 20% | | |
| Custom Colors | Please call for availability on custom stain matches | | | | 15% (min. \$350) | | |
| | High Gloss | | | | 15% | | |
| Touch-up Crayons (in all colors) | Specify Color | | | | \$16 | | |
| Touch-up Markers (in all colors) | Specify Color | | | | \$22 | | |

Office

Sizes are nominal.

Office Series

Hand Selected Veneer with an 8 Way Hardwood Radius Edge Boasts a Contemporary Design.



| | Model Number | Description | List |
|--|------------------------|--|---------------------------------|
| Grommet | Op-Grom | (Installed) Hardware, Grommet, 60mm Cable, Black | \$62 |
| | Powered Grommet | Op-Pwr-Grom | Retractable Power Grommet black |
| Power Grommets Holds 1 or 2 Data Modules Only. | Op-IL-RJ11-Cat. 3 | In-line data module, RJ 11Cat. 3 black | \$48 |
| | Op-IL-RJ45-Cat. 3 | In-line data module, RJ 45 Cat. 3 black | \$48 |
| | Op-HW-RJ11-Cat. 3 | Hard wire data module, RJ 11 Cat. 3 black | \$48 |
| | Op-HW-RJ45-Cat. 3 | Hard wire data module, RJ 45 Cat. 3 black | \$48 |
| | Op-HW-RJ45-Cat. 5 | Hard wire data module, RJ 45 Cat. 5 black | \$48 |
| | Op-HW-RJ45-Cat. 6 | Hard wire data module, RJ 45 Cat. 6 orange | \$82 |

Grommet Placement Guide

When choosing an optional grommet, please use the drawings below to determine where you would like the grommet placed on the worksurface. For grommet placement in the modesty panels, place an "M" ahead of the number. Grommets through modesty panels are positioned at the highest possible point on the modesty panel. For example: To have the grommet placed in the center of the modesty panel of a return, indicate "M1" on the order line for that item.

Please Note: Grommets cannot go through pedestals on 20" depth units.

Single Pedestal Right

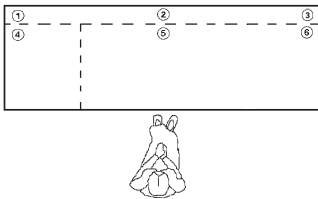

Single Pedestal Left

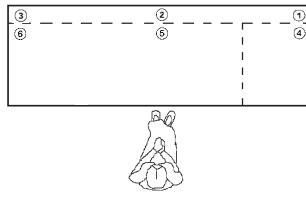

Double Pedestal

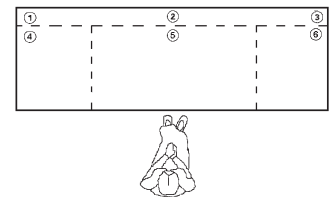

Computer Corner Credenzas

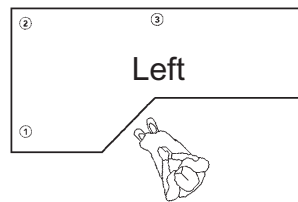
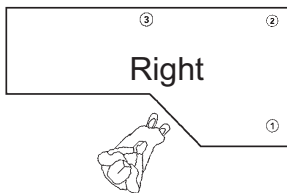

Credenzas

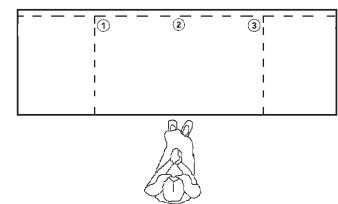

Return Right

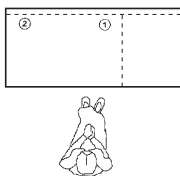

Return Left

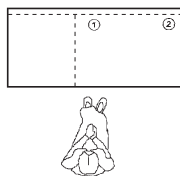

Conference Tables

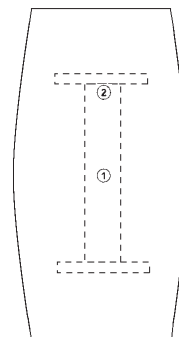

Bullet/P-tops

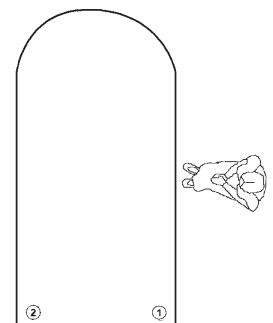

Computer Corner

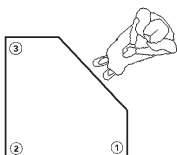

Bridges

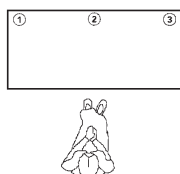

Office Series

Hand Selected Veneer with an 8 Way Hardwood Radius Edge Boasts a Contemporary Design.



Crescent Pull



Wire Pull



Button Pull



Tab Pull



Standard Pull



Traditional Pull



| Model Number | Description | Width | Height | Depth | List |
|--------------|--------------------------|-------|--------|-------|------|
| Op-B1 | Standard Pull Black | 278mm | 18mm | 10mm | \$38 |
| Op-N1 | Standard Pull Nickel | 278mm | 18mm | 10mm | \$38 |
| Op-B2 | Tab Pull Black | 40mm | 26mm | 8mm | \$38 |
| Op-N2 | Tab Pull Nickel | 40mm | 26mm | 8mm | \$38 |
| Op-B3 | Wire Pull Black | 153mm | 30mm | 10mm | \$38 |
| Op-N3 | Wire Pull Nickel | 153mm | 30mm | 10mm | \$38 |
| Op-B4 | Button Pull Black | 31mm | 28mm | 15mm | \$38 |
| Op-N4 | Button Pull Nickel | 31mm | 28mm | 15mm | \$38 |
| Op-B5 | Crescent Pull Black | 100mm | 24mm | 22mm | \$38 |
| Op-N5 | Crescent Pull Nickel | 100mm | 24mm | 22mm | \$38 |
| Op-A6 | Traditional Pull Antique | 147mm | 48mm | 14mm | \$38 |

HARDWARE:

| | Depth | Width | Height | List | Weight | Cube | |
|---|--|-------|--------|------|--------|------|---|
| Standard Keyboard Tray | KBT-Standard | 20 | 22 | 2 | \$118 | 10 | 2 |
| Standard Keyboard Tray With Mouse Tray | KBT-Standard-MT | 20 | 22 | 3 | \$196 | 10 | 2 |
| Keyboard Tray With Articulating Arm and Mouse Tray | KBT-ArtArm-MT | 20 | 27 | 4 | \$356 | 10 | 2 |
| Desk Lock | Op-DESK-LOCK | | | | \$62 | | |
| Casters | OP-Casters (add 2" to height) | | | 2 | \$128 | | |
| Cartoning | Corner guards, cardboard top, & sides (Priced per box) | | | | \$74 | | |
| | Bubble Wrap | | | | \$74 | | |
| | Bubble Wrap & Palletize | | | | \$126 | | |

Sizes are nominal.



NOTES

8200 Series

Veneer

Our Hand Selected Veneers Set the Veneer Standard for Excellence Expected by the Discerning Customer.

Standard Features:

- Full Suspension on all Drawers.
- Box/File Pedestals.
- 1/2" 9 Ply UV Coated Birch Drawer Material
- Touch Latch Doors on Credenzas.
- File Drawers Supplied with Rods for Hanging Legal and Letter Files.
- 20" Depth on Credenzas, Returns, Lateral Files, and Bridges.
- Locks Keyed Alike.

- Matching Vertical Grain Drawer Fronts.
- Solid Hardwood 4 Way Edge on Top
- Available in Five Profiles.
- One Piece Vertical Grain Modesty Panels.
- Flush Height Returns.
- Adjustable Leveling Glides (except Bookcases).
- Full Modesty Panels Standard on Desks.
- Hardwood Molding on Bottom of Side Panels.
- Catalyzed Conversion Varnish Finish.

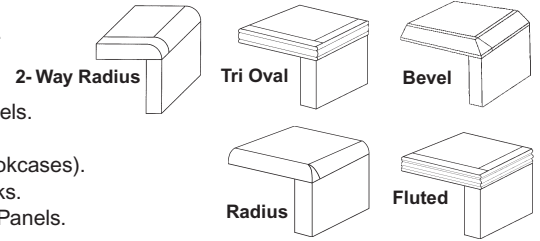

Desks - Double Pedestal/Single Pedestal/ Fan Top Desk (DP/SP/FDP)

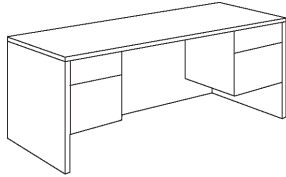

| Model Number | Depth | Width | Height | List | Weight | Cube |
|--|-------|-------|--------|---------|--------|------|
| 82-DP-3060 w/2 locks | 30 | 60 | 29 | \$1,390 | 285 | 36 |
| 82-DP-3066 w/2 locks | 30 | 66 | 29 | \$1,488 | 290 | 40 |
| 82-DP-3672 w/2 locks | 36 | 72 | 29 | \$1,676 | 310 | 51 |
| 82-SP-2448 w/1 lock | 24 | 48 | 29 | \$894 | 145 | 24 |
| \$264 List to add 6" increments (\$122 List cut downs) | | | | | | |
| 82-FDP-3066 w/2 locks | 36 | 66 | 29 | \$1,988 | 320 | 51 |
| 82-FDP-3672 w/2 locks | 42 | 72 | 29 | \$2,176 | 345 | 59 |
| \$350 List to add 6" increments (\$210 List cut downs) | | | | | | |
| 82-C-2060-Cab | 20 | 60 | 29 | \$1,390 | 233 | 25 |
| 82-C-2060-Open | 20 | 60 | 29 | \$1,390 | 215 | 25 |
| 82-C-2066-Cab | 20 | 66 | 29 | \$1,488 | 239 | 27 |
| 82-C-2066-Open | 20 | 66 | 29 | \$1,488 | 221 | 27 |
| 82-C-2072-Cab | 20 | 72 | 29 | \$1,676 | 245 | 30 |
| 82-C-2072-Open | 20 | 72 | 29 | \$1,676 | 227 | 30 |
| 24" Credenza depth add \$264 List | | | | | | |
| \$264 List to add 6" increments (\$122 List cut downs) | | | | | | |
| 82-DR-3060-2042 | 72 | 60 | 29 | \$2,116 | 305 | 54 |
| • 82-Dsp-3060 w/1 lock | 30 | 60 | 29 | \$1,336 | 210 | 36 |
| • 82-Ret-2042 | 20 | 42 | 29 | \$780 | 95 | 18 |
| 82-DR-3066-2447 | 77 | 66 | 29 | \$2,394 | 350 | 63 |
| • 82-Dsp-3066 w/1 lock | 30 | 66 | 29 | \$1,386 | 225 | 40 |
| • 82-Ret-2447 | 24 | 47 | 29 | \$1,008 | 125 | 23 |
| 82-DR-3672-2047 | 83 | 72 | 29 | \$2,630 | 335 | 69 |
| • 82-Dsp-3672 w/1 lock | 36 | 72 | 29 | \$1,622 | 235 | 51 |
| • 82-Ret-2047 | 20 | 47 | 29 | \$1,008 | 100 | 18 |
| 82-DR-3672-2447 | 83 | 72 | 29 | \$2,630 | 360 | 74 |
| • 82-Dsp-3672 w/1 lock | 36 | 72 | 29 | \$1,622 | 235 | 51 |
| • 82-Ret-2447 | 24 | 47 | 29 | \$1,008 | 125 | 23 |
| Fan & P-Top Available (See Components) | | | | | | |
| \$264 List to add 6" increments (\$122 List cut downs) | | | | | | |
| 82-Recep-3072-2447 | 77 | 72 | 43 | \$4,492 | 565 | 96 |
| • 82-Recep-3072 w/1 lock | 30 | 72 | 43 | \$3,144 | 400 | 62 |
| • 82-Recep-Ret-2447 | 24 | 47 | 43 | \$1,348 | 165 | 34 |
| \$526 List to add 6" increments (\$264 List cut downs) | | | | | | |

Credenzas (C-Open/C-Cab)

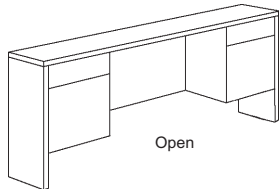

Desks with Return (DR)

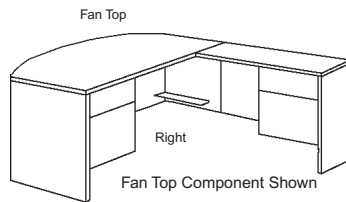
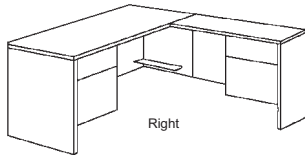

Reception Unit (Recep)

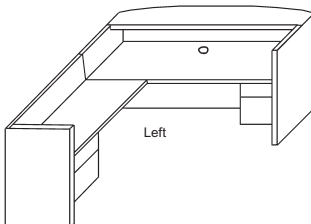

8200

Sizes are nominal.

8200 Series

Our Hand Selected Veneers Set the Veneer Standard for Excellence Expected by the Discerning Customer.

Hutches (H,CH,H-Filler,H-Organizer)

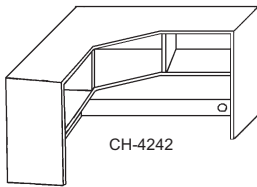
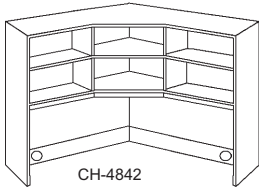
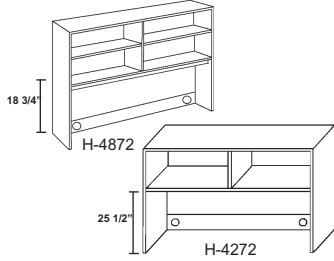

Work Tables (WT)

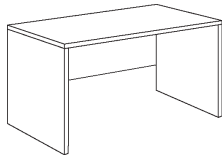

Lateral Files (LF)

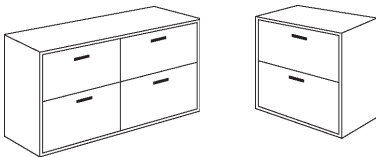

Vertical Files (VF)

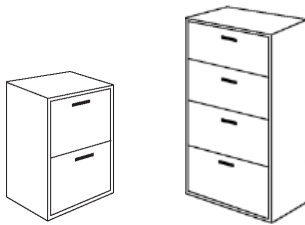

Occasional Tables (OT)

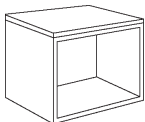

| Model Number | Depth | Width | Height | List | Weight | Cube |
|--|-------|-------|--------|---------|--------|------|
| 82-H-4845 | 14 | 45 | 48 | \$1,256 | 150 | 24 |
| 82-H-4857 | 14 | 57 | 48 | \$1,256 | 165 | 28 |
| 82-H-4863 | 14 | 63 | 48 | \$1,368 | 172 | 30 |
| 82-H-4869 | 14 | 69 | 48 | \$1,368 | 180 | 33 |
| 82-H-4245 | 14 | 45 | 43 | \$1,058 | 130 | 20 |
| 82-H-4257 | 14 | 57 | 43 | \$1,058 | 145 | 25 |
| 82-H-4263 | 14 | 63 | 43 | \$1,168 | 152 | 27 |
| 82-H-4269 | 14 | 69 | 43 | \$1,168 | 160 | 30 |
| 82-CH-4842 | 42 | 42 | 48 | \$1,700 | 180 | 56 |
| 82-CH-4836 | 36 | 36 | 48 | \$1,646 | 165 | 42 |
| 82-CH-4242 | 42 | 42 | 43 | \$1,408 | 160 | 50 |
| 82-CH-4236 | 36 | 36 | 43 | \$1,376 | 145 | 37 |
| 82-H-48-Filler (Fills space between hutches) | 1 | 4 | 48 | \$168 | 3 | 1 |
| 82-H-42-Filler | 1 | 4 | 42 | \$168 | 3 | 1 |
| OP-H-Organizer | 10 | 12 | 12 | \$168 | 4 | 1 |
| \$210 List cut downs (not available on corner hutch) | | | | | | |
| wood standard See options for door configurations | | | | | | |
| 82-WT-2036 | 20 | 36 | 29 | \$572 | 70 | 15 |
| 82-WT-2042 | 20 | 42 | 29 | \$644 | 90 | 18 |
| 82-WT-2048 | 20 | 48 | 29 | \$736 | 105 | 20 |
| 82-WT-2060 | 20 | 60 | 29 | \$782 | 110 | 25 |
| 82-WT-2072 | 20 | 72 | 29 | \$934 | 125 | 30 |
| 82-WT-2448 | 24 | 48 | 29 | \$652 | 120 | 24 |
| 82-WT-3048 | 30 | 48 | 29 | \$760 | 140 | 29 |
| 82-WT-3060 | 30 | 60 | 29 | \$934 | 150 | 36 |
| 82-WT-3672 | 36 | 72 | 29 | \$1,198 | 170 | 51 |
| \$264 List to add 6" increments (\$122 List cut downs) | | | | | | |
| 82-LF-2038-2D w/handles (B1) | 20 | 38 | 29 | \$1,220 | 185 | 16 |
| 82-LF-2072-4D w/handles (B1) | 20 | 72 | 29 | \$1,954 | 345 | 30 |
| Locks Standard | | | | | | |
| 82-VF-2423-2D w/handles (B1) | 24 | 23 | 29 | \$992 | 130 | 12 |
| 82-VF-2423-4D w/handles (B1) | 24 | 23 | 54 | \$1,522 | 260 | 21 |
| 82-VLF-2038-4D w/handles (B1) | 20 | 38 | 54 | \$2,136 | 345 | 30 |
| Locks Standard | | | | | | |
| 82-OT-2020 | 20 | 20 | 20 | \$472 | 45 | 7 |
| 82-OT-2048 | 20 | 48 | 20 | \$652 | 70 | 15 |
| \$264 List to add 6" increments (\$122 List cut downs) | | | | | | |

Sizes are nominal.

8200 Series

Our Hand Selected Veneers Set the Veneer Standard for Excellence Expected by the Discerning Customer.

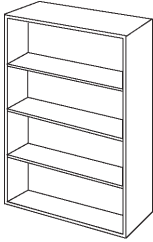
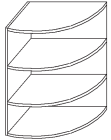
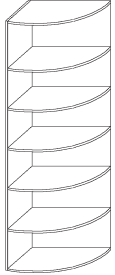
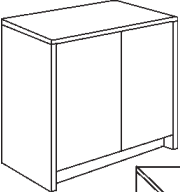
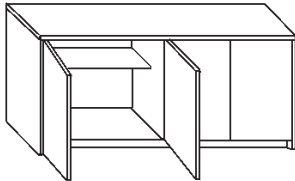
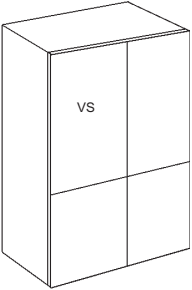
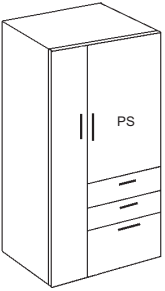
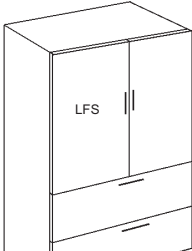
| | Model Number | Depth | Width | Height | List | Weight | Cube |
|--|--|-------|-------|--------|---------|--------|------|
| Bookcases (BC)  | 82-BC-2936-1 | 12 | 36 | 29 | \$418 | 70 | 10 |
| | 82-BC-4834-2L For 2-D Lateral No Bottom | 14 | 34 | 48 | \$560 | 75 | 15 |
| | 82-BC-4836-2 | 12 | 36 | 48 | \$560 | 85 | 16 |
| | 82-BC-6036-3 | 12 | 36 | 60 | \$718 | 100 | 20 |
| | 82-BC-7236-4 | 12 | 36 | 72 | \$878 | 115 | 23 |
| | 82-BC-8436-5 | 12 | 36 | 84 | \$984 | 140 | 27 |
| | 82-BC-3612-BKSLF Bookcase Shelf | 12 | 36 | .75 | \$62 | 4 | 1 |
| | 82-BC-L-Cab 29" Lower Cabinet (72" & 84" only) | | | | \$296 | 15 | |
| Corner Bookcases / Corner Bookcase Hutch (CBC / CBCH)   | (\$210 List cut downs) | | | | | | |
| | 82-CBC-2029-1 | 20 | 20 | 29 | \$738 | 70 | 9 |
| | 82-CBC-2072-4 | 20 | 20 | 72 | \$1,082 | 115 | 21 |
| | 82-CBCH-1448 | 14 | 14 | 48 | \$830 | 70 | 8 |
| | 82-CBCH-1442 | 14 | 14 | 42 | \$830 | 65 | 7 |
| Storage Cabinets (SC)   | 82-SC-2019 | 20 | 19 | 29 | \$780 | 110 | 8 |
| | 82-SC-2032 | 20 | 32 | 29 | \$974 | 120 | 13 |
| | 82-SC-2038 | 20 | 38 | 29 | \$1,136 | 130 | 15 |
| | 82-SC-2060 | 20 | 60 | 29 | \$1,586 | 155 | 25 |
| | 82-SC-2072 | 20 | 72 | 29 | \$1,866 | 165 | 30 |
| | | | | | | | |
| Storage - Vertical / Personal / Lateral File (VS/PS/LFS)    | 82-VS-3872 Door Locks Optional | 20 | 38 | 72 | \$1,712 | 330 | 38 |
| | 82-PS-3072 Door Locks Optional (BBF lock not available) Specify right or left (right shown) w/handles (B1) | 20 | 30 | 72 | \$2,616 | 340 | 30 |
| | 82-LFS-3872 W/1 lock on LAT Door Locks Optional w/handles (B1) | 20 | 38 | 72 | \$2,332 | 350 | 38 |
| | | | | | | | |
| | | | | | | | |

8200

Sizes are nominal.

8200 Series

Our Hand Selected Veneers Set the Veneer Standard for Excellence Expected by the Discerning Customer.

Computer U-Shape Desks (CU)

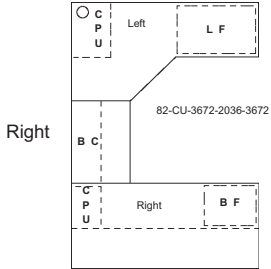

U-Shape Desks (NCU)

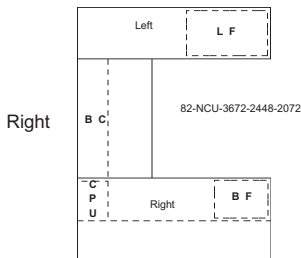

Bullet Computer U-Shape Desks (BCU)

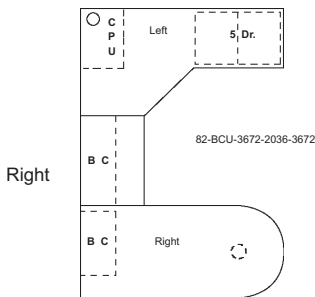

Bullet U-Shape Desks (BNCU)

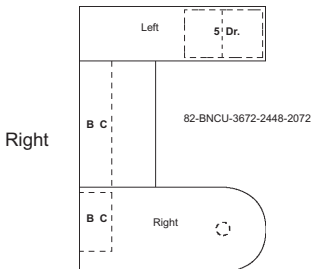

Computer Corner with Return (CR)

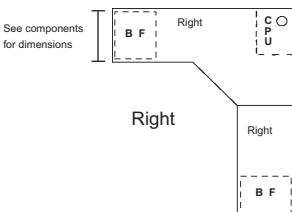

| Model Number | Depth | Width | Height | List | Weight | Cube |
|--|-------|-------|--------|---------|--------|------|
| 82-CU-3066-2036-3666 | 102 | 66 | 29 | \$4,224 | 545 | 102 |
| • 82-Dsp-3066 w/1 lock | 30 | 66 | 29 | \$1,386 | 225 | 40 |
| • 82-BR-2036-BC | 20 | 36 | 29 | \$724 | 105 | 15 |
| • 82-CCCsp-3666 | 36 | 66 | 29 | \$2,114 | 215 | 47 |
| 82-CU-3672-2036-3672 | 108 | 72 | 29 | \$4,626 | 605 | 117 |
| • 82-Dsp-3672 w/1 lock | 36 | 72 | 29 | \$1,622 | 235 | 51 |
| • 82-BR-2036-BC | 20 | 36 | 29 | \$724 | 105 | 15 |
| • 82-CCCsp-3672-LF w/1 lock | 36 | 72 | 29 | \$2,280 | 265 | 51 |
| w/handles (B1) | | | | | | |
| See components for cutdowns | | | | | | |
| 82-NCU-3672-2448-2072 | 103 | 72 | 29 | \$4,070 | 575 | 104 |
| • 82-Dsp-3672 w/1 lock | 36 | 72 | 29 | \$1,622 | 235 | 51 |
| • 82-BR-2447-BC | 24 | 47 | 29 | \$890 | 125 | 23 |
| • 82-Csp-2072-LF w/1 lock | 20 | 72 | 29 | \$1,558 | 215 | 30 |
| w/handles (B1) | | | | | | |
| Fan & P-Top Available (See Components) | | | | | | |
| See components for cutdowns | | | | | | |
| 82-BCU-3672-2036-3672 | 108 | 72 | 29 | \$4,954 | 520 | 117 |
| • 82-B-3672 | 36 | 72 | 29 | \$1,892 | 150 | 51 |
| • 82-BR-2036-BC | 20 | 36 | 29 | \$724 | 105 | 15 |
| • 82-CCCsp-3672-5DR | 36 | 72 | 29 | \$2,338 | 265 | 51 |
| w/handles (B1) | | | | | | |
| 82-BCU-3684-2036-3672 | 108 | 84 | 29 | \$5,066 | 535 | 125 |
| • 82-B-3684 | 36 | 84 | 29 | \$2,004 | 165 | 59 |
| • 82-BR-2036-BC | 20 | 36 | 29 | \$724 | 105 | 15 |
| • 82-CCCsp-3672-5DR | 36 | 72 | 29 | \$2,338 | 265 | 51 |
| w/handles (B1) | | | | | | |
| Cylinder MOD Optional | | | | | | |
| See components for cutdowns | | | | | | |
| 82-BNCU-3672-2448-2072 | 103 | 72 | 29 | \$4,342 | 490 | 104 |
| • 82-B-3672 | 36 | 72 | 29 | \$1,892 | 150 | 51 |
| • 82-BR-2447-BC | 24 | 47 | 29 | \$890 | 125 | 23 |
| • 82-Csp-2072-5DR | 20 | 72 | 29 | \$1,560 | 215 | 30 |
| w/handles (B1) | | | | | | |
| Cylinder MOD Optional | | | | | | |
| Fan & P-Top Available (See Components) | | | | | | |
| See components for cutdowns | | | | | | |
| 82-CR-3666-2042 | 78 | 66 | 29 | \$2,894 | 310 | 65 |
| • 82-CCCsp-3666 | 36 | 66 | 29 | \$2,114 | 215 | 47 |
| • 82-Ret-2042 | 20 | 42 | 29 | \$780 | 95 | 18 |
| 82-CR-3672-2447 | 83 | 72 | 29 | \$3,122 | 350 | 74 |
| • 82-CCDsp-3672 | 36 | 72 | 29 | \$2,114 | 225 | 51 |
| • 82-Ret-2447 | 24 | 47 | 29 | \$1,008 | 125 | 23 |
| See components for cutdowns | | | | | | |

Sizes are nominal.

8200 Series

Our Hand Selected Veneers Set the Veneer Standard for Excellence Expected by the Discerning Customer.

How to Specify Left or Right Components

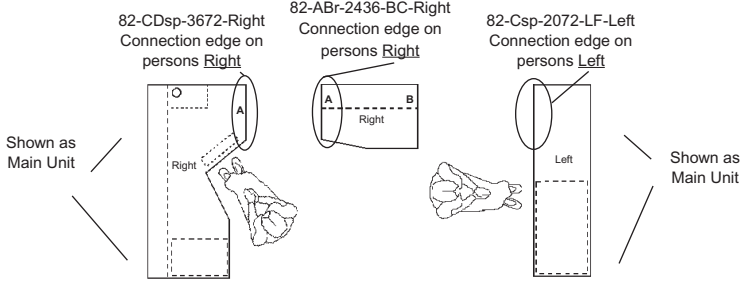

“Right” = Connects to Right side of main desk.

“Left” = Connects to Left side of main desk.

“A” = 20” Width

“B” = 24” Width

Components

| | Model Number | Depth | Width | Height | List | Weight | Cube |
|-----------------------------|--|--|-------|--------|---------|--------|------|
| Desk Tops | 82-Dsp-3060 w/1 lock | 30 | 60 | 29 | \$1,336 | 210 | 36 |
| | 82-Dsp-3066 w/1 lock | 30 | 66 | 29 | \$1,386 | 225 | 40 |
| | 82-Dsp-3672 w/1 lock | 36 | 72 | 29 | \$1,622 | 235 | 51 |
| | \$264 List to add 6" increments (\$122 List cut downs) | | | | | | |
| | 82-CDsp-3672 w/1 lock | 36 | 72 | 29 | \$1,992 | 225 | 51 |
| Fan Tops | 82-FDsp-3066 w/1 lock | 36 | 66 | 29 | \$1,886 | 260 | 51 |
| | 82-FDsp-3672 w/1 lock | 42 | 72 | 29 | \$2,122 | 270 | 59 |
| | | \$350 List to add 6" increments (\$210 List cut downs) | | | | | |
| | 82-FCDsp-3672 w/1 lock | 42 | 72 | 29 | \$2,398 | 265 | 59 |
| Bullet Tops | 82-B-3672 | 36 | 72 | 29 | \$1,892 | 150 | 51 |
| | 82-B-3684 | 36 | 84 | 29 | \$2,004 | 165 | 59 |
| | Cylinder MOD Optional | | | | | | |
| | \$350 List to add 6" increments (\$210 List cut downs) | | | | | | |
| Computer Bullet Tops | 82-CB-3672 | 36 | 72 | 29 | \$2,168 | 145 | 51 |
| | 82-CB-3684 | 36 | 84 | 29 | \$2,280 | 155 | 59 |
| | Cylinder MOD Optional | | | | | | |
| P-Tops | 82-P-3672 | 42 | 72 | 29 | \$1,892 | 190 | 59 |
| | Cylinder MOD Optional | | | | | | |
| | \$350 List to add 6" increments (\$210 List cut downs) | | | | | | |

Sizes are nominal.

8200 Series

Our Hand Selected Veneers Set the Veneer Standard for Excellence Expected by the Discerning Customer.

Computer P-Tops

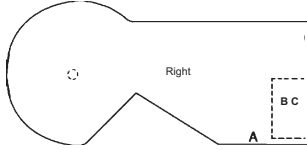

Computer Corners & Credenzas

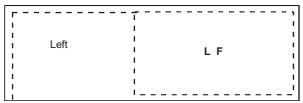
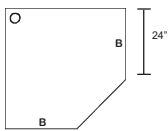
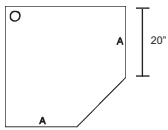
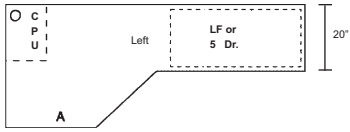
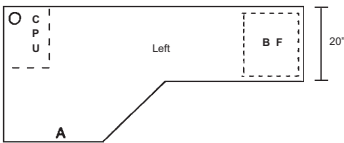
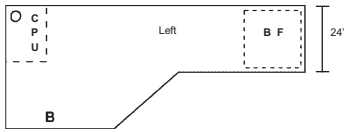

| Model Number | Depth | Width | Height | List | Weight | Cube |
|--|-------|-------|--------|---------|--------|------|
| 82-CP-3672 Cylinder MOD Optional | 48 | 72 | 29 | \$2,378 | 170 | 67 |
| 82-CCDsp-3672 | 36 | 72 | 29 | \$2,114 | 225 | 51 |
| 82-CCCsp-3666 | 36 | 66 | 29 | \$2,114 | 215 | 47 |
| 82-CCCsp-3672-LF w/1 lock w/handles (B1) | 36 | 72 | 29 | \$2,280 | 265 | 51 |
| 82-CCCsp-3672-5DR w/handles (B1) | 36 | 72 | 29 | \$2,338 | 265 | 51 |
| \$350 List to add 6" increments (\$210 List cut downs) | | | | | | |
| 82-CC-3636-20 | 36 | 36 | 29 | \$992 | 135 | 26 |
| 82-CC-4242-20 | 42 | 42 | 29 | \$1,144 | 175 | 35 |
| 82-CC-3636-24 | 36 | 36 | 29 | \$992 | 135 | 26 |
| 82-CC-4242-24 | 42 | 42 | 29 | \$1,144 | 175 | 35 |
| 82-Csp-2060 | 20 | 60 | 29 | \$1,336 | 175 | 25 |
| 82-Csp-2072 | 20 | 72 | 29 | \$1,622 | 195 | 30 |
| 82-Csp-2060-LF w/1 lock w/handles (B1) | 20 | 60 | 29 | \$1,390 | 205 | 25 |
| 82-Csp-2072-LF w/1 lock w/handles (B1) | 20 | 72 | 29 | \$1,558 | 215 | 30 |
| 82-Csp-2072-5DR w/handles (B1) | 20 | 72 | 29 | \$1,560 | 215 | 30 |
| \$264 List to add 6" increments (\$122 List cut downs) | | | | | | |

Sizes are nominal.

8200 Series

Solid Hardwood Edges, Laminate, Available in Four Profiles, Introduce Artistic Flair to These Stylish Designs.

Returns-20" W/BF Pedestals

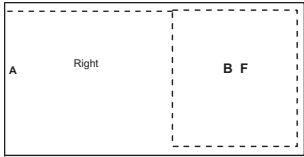

Returns-24" W/BF Pedestals

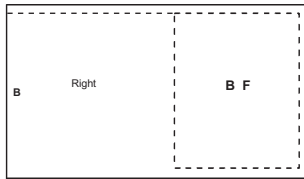

Rectangular Bridges W/Bookcase

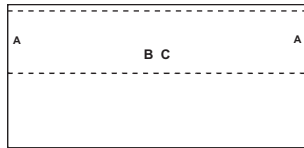

Angled Returns-24" W/BF Pedestals

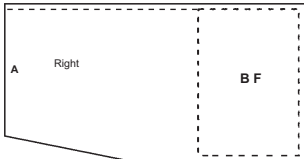

Angled Bridge-24" W/Bookcase

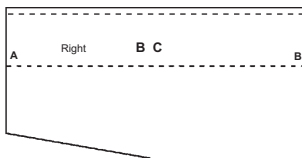

| Model Number | Depth | Width | Height | List | Weight | Cube |
|--|-------|-------|--------|---------|--------|------|
| 82-Ret-2042 | 20 | 42 | 29 | \$780 | 95 | 18 |
| 82-Ret-2047 | 20 | 47 | 29 | \$1,008 | 100 | 18 |
| \$264 List to add 6" increments (\$122 List cut downs) | | | | | | |
| 82-Ret-2436 | 24 | 36 | 29 | \$880 | 105 | 18 |
| 82-Ret-2447 | 24 | 47 | 29 | \$1,008 | 125 | 23 |
| \$264 List to add 6" increments (\$122 List cut downs) | | | | | | |
| 82-BR-2036-BC | 20 | 36 | 29 | \$724 | 105 | 15 |
| 82-BR-2447-BC | 24 | 47 | 29 | \$890 | 125 | 23 |
| \$264 List to add 6" increments (\$122 List cut downs) | | | | | | |
| 82-ARet-2436 | 24 | 36 | 29 | \$990 | 100 | 18 |
| 82-ARet-2447 | 24 | 47 | 29 | \$1,118 | 115 | 23 |
| \$264 List to add 6" increments (\$176 List cut downs) | | | | | | |
| 82-ABr-2436-BC | 24 | 36 | 29 | \$872 | 110 | 18 |
| 82-ABr-2447-BC | 24 | 47 | 29 | \$1,000 | 120 | 23 |
| \$264 List to add 6" increments (\$176 List cut downs) | | | | | | |

8200

Sizes are nominal.

8200 Series

Our Hand Selected Veneers Set the Veneer Standard for Excellence Expected by the Discerning Customer.

Conference Table Top Edge Details

Tri - Oval

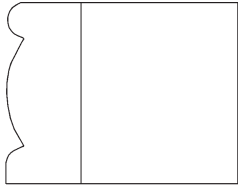

Fluted



Radius

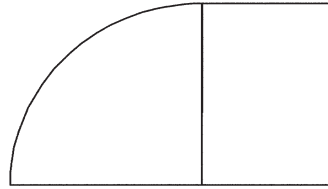

Bevel

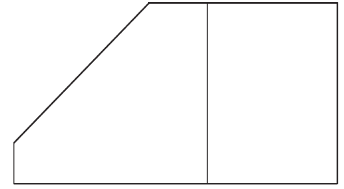

Standard Edge Details

P-7

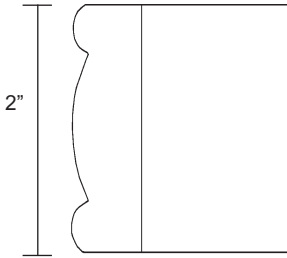

P-8

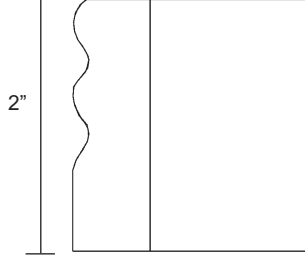

P-9

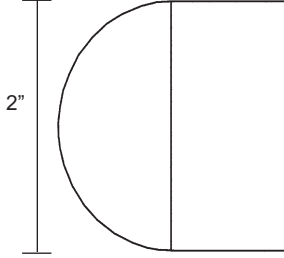

P-10

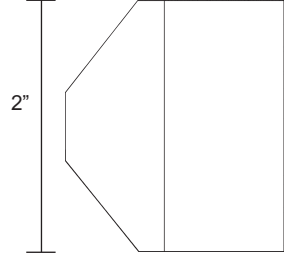

25% Upcharge On 2" Tops Only

Racetrack Conference Table (RACE)

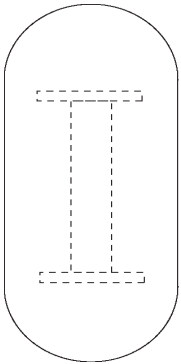

Round Conference Table (RND)

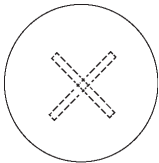

| Model Number | Depth | Width | Height | List | Weight | Cube |
|---|-------|-------|--------|---------|--------|------|
| 82-3672-Race | 36 | 72 | 29 | \$2,344 | 135 | 22 |
| • 82-3672-Race-TOP | 36 | 72 | 1.2 | \$1,954 | 85 | 6 |
| • 82-3672-Rec-Boat-BASE | 24 | 31 | 29 | \$390 | 50 | 16 |
| 82-4896-Race | 48 | 96 | 29 | \$2,734 | 198 | 37 |
| • 82-4896-Race-TOP | 48 | 96 | 1.2 | \$2,246 | 143 | 10 |
| • 82-4896-Rec-Boat-BASE | 24 | 55 | 29 | \$488 | 55 | 27 |
| 82-48120-Race | 48 | 120 | 29 | \$3,380 | 252 | 51 |
| • 82-48120-Race-TOP | 48 | 120 | 1.2 | \$2,730 | 177 | 12 |
| • 82-48120-Rec-Boat-BASE | 24 | 81 | 29 | \$650 | 75 | 39 |
| 82-48144-Race | 48 | 144 | 29 | \$4,414 | 312 | 66 |
| • 82-48144-Race-TOP | 48 | 144 | 1.2 | \$3,506 | 212 | 14 |
| • 82-48144-Rec-Boat-BASE | 24 | 108 | 29 | \$908 | 100 | 52 |
| Top 2-Piece Base 2-Piece | | | | | | |
| <small>\$526 List to add 12" increments (\$210 List cut downs) add 50% for 60" wide</small> | | | | | | |
| 82-36-RND | 36 | 36 | 29 | \$1,176 | 100 | 16 |
| • 82-36-RND-TOP | 36 | 36 | 1.2 | \$854 | 62 | 3 |
| • 82-X-Base | 24 | 24 | 29 | \$322 | 38 | 13 |
| 82-42-RND | 42 | 42 | 29 | \$1,288 | 118 | 17 |
| • 82-42-RND-TOP | 42 | 42 | 1.2 | \$966 | 80 | 4 |
| • 82-X-Base | 24 | 24 | 29 | \$322 | 38 | 13 |
| 82-48-RND | 48 | 48 | 29 | \$1,288 | 128 | 18 |
| • 82-48-RND-TOP | 48 | 48 | 1.2 | \$966 | 90 | 5 |
| • 82-X-Base | 24 | 24 | 29 | \$322 | 38 | 13 |
| add 50% for 60" | | | | | | |

Sizes are nominal.

8200 Series

Our Hand Selected Veneers Set the Veneer Standard for Excellence Expected by the Discerning Customer.

Boat Shape Conference Table (BOAT)

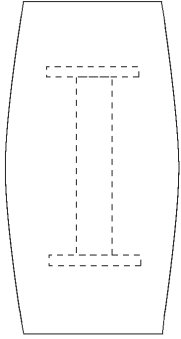

| Model Number | Depth | Width | Height | List | Weight | Cube |
|--|-------|-------|--------|---------|--------|------|
| 82-3672-Boat | 36 | 72 | 29 | \$1,558 | 135 | 22 |
| • 82-3672-Boat-TOP | 36 | 72 | 1.2 | \$1,168 | 85 | 6 |
| • 82-3672-Rec-Boat-BASE | 24 | 31 | 29 | \$390 | 50 | 16 |
| 82-4896-Boat | 48 | 96 | 29 | \$1,954 | 198 | 37 |
| • 82-4896-Boat-TOP | 48 | 96 | 1.2 | \$1,466 | 143 | 10 |
| • 82-4896-Rec-Boat-BASE | 24 | 55 | 29 | \$488 | 55 | 27 |
| 82-48120-Boat | 48 | 120 | 29 | \$2,598 | 252 | 51 |
| • 82-48120-Boat-TOP | 48 | 120 | 1.2 | \$1,948 | 177 | 12 |
| • 82-48120-Rec-Boat-BASE | 24 | 81 | 29 | \$650 | 75 | 39 |
| 82-48144-Boat | 48 | 144 | 29 | \$3,634 | 312 | 66 |
| • 82-48144-Boat-TOP | 48 | 144 | 1.2 | \$2,726 | 212 | 14 |
| • 82-48144-Rec-Boat-Base | 24 | 108 | 29 | \$908 | 100 | 52 |
| Top 2-Piece Base 2-Piece | | | | | | |
| \$526 List to add 12" increments (\$210 List cut downs) add 50% for 60" wide | | | | | | |

Rectangle Conference Table (BOAT)

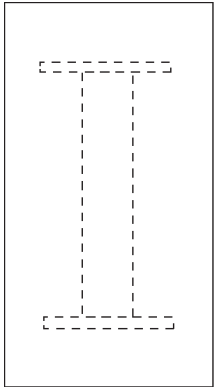

| | | | | | | |
|--|----|-----|-----|---------|-----|----|
| 82-3672-Rec | 36 | 72 | 29 | \$1,558 | 135 | 22 |
| • 82-3672-Rec-TOP | 36 | 72 | 1.2 | \$1,168 | 85 | 6 |
| • 82-3672-Rec-Boat-BASE | 24 | 31 | 29 | \$390 | 50 | 16 |
| 82-4896-Rec | 48 | 96 | 29 | \$1,954 | 198 | 37 |
| • 82-4896-Rec-TOP | 48 | 96 | 1.2 | \$1,466 | 143 | 10 |
| • 82-4896-Rec-Boat-BASE | 24 | 55 | 29 | \$488 | 55 | 27 |
| 82-48120-Rec | 48 | 120 | 29 | \$2,598 | 252 | 51 |
| • 82-48120-Rec-TOP | 48 | 120 | 1.2 | \$1,948 | 177 | 12 |
| • 82-48120-Rec-Boat-BASE | 24 | 81 | 29 | \$650 | 75 | 39 |
| 82-48144-Rec | 48 | 144 | 29 | \$3,634 | 312 | 66 |
| • 82-48144-Rec-TOP | 48 | 144 | 1.2 | \$2,726 | 212 | 14 |
| • 82-48144-Rec-Boat-Base | 24 | 108 | 29 | \$908 | 100 | 52 |
| Top 2-Piece Base 2-Piece | | | | | | |
| \$526 List to add 12" increments (\$210 List cut downs) add 50% for 60" wide | | | | | | |

Conference Cabinets (CFC)

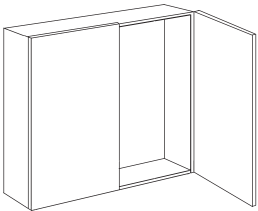

| | | | | | | |
|-------------|---|----|----|---------|----|----|
| 82-CFC-3636 | 5 | 36 | 36 | \$1,764 | 65 | 6 |
| 82-CFC-4848 | 5 | 48 | 48 | \$1,764 | 75 | 11 |
| | | | | | | |
| | | | | | | |
| | | | | | | |
| | | | | | | |

Lectern (LT)

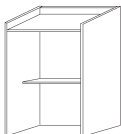

| | | | | | | |
|------------|----|----|----|---------|-----|----|
| 82-LT-2030 | 20 | 30 | 46 | \$1,198 | 105 | 15 |
| | | | | | | |
| | | | | | | |
| | | | | | | |

Sizes are nominal.



8200 Series

Our Hand Selected Veneers Set the Veneer Standard for Excellence Expected by the Discerning Customer.

| | Model Number | Depth | Width | Height | List | Weight | Cube |
|---|---|-------|-------|--------|---------|--------|------|
| Cylinder Bases | • 82-Cylinder BASE | 18 | 18 | 27 | \$488 | 25 | 10 |
| | • 82-1/2 Cylinder BASE | 18 | 9 | 27 | \$488 | 18 | 6 |
| | All Tables w/ Cylinder Base, Must Be Ordered in Components Pieces | | | | | | |
| | add 50% for 30" | | | | | | |
| Wall Hanging Overhead (OH) | 82-OH-1634 | 14 | 34 | 16 | \$652 | 70 | 7 |
| | 82-OH-3034 | 14 | 34 | 28 | \$820 | 130 | 11 |
| | Doors not standard See options for door configurations | | | | | | |
| Stand Alone Pedestals (PED) | 82-PED-2017-FP-SA | 19 | 17 | 27 | \$634 | 45 | 7 |
| | Specify - Box/Box/File or File/File | | | | | | |
| | 82-PED-2036-LF-SA | 19 | 36 | 27 | \$1,114 | 65 | 14 |
| | w/handles (B1) | | | | | | |
| | 82-PED-2033-5DR-SA | 19 | 33 | 27 | \$1,222 | 70 | 13 |
| | w/handles (B1) | | | | | | |
| | 82-PED-2036-SC-SA | 19 | 36 | 27 | \$1,114 | 65 | 14 |
| | Note - Peds have unfinished backs | | | | | | |
| | See hardware for casters | | | | | | |
| | Adding casters will make unit 29 high | | | | | | |
| Built in Printer and CPU Pullouts (PPO, CPU) | 82-PPO-20 | 19 | 22 | 20 | \$568 | 15 | |
| | 82-CPU-PO-20 | 19 | 12 | 20 | \$430 | 10 | |
| | 20" depth units only | | | | | | |
| | 82-PPO-24 | 23 | 22 | 24 | \$568 | 17 | |
| | 82-CPU-PO-24 | 23 | 12 | 24 | \$430 | 12 | |
| | 24", 30", 36" depth units only | | | | | | |
| | Must be added to no ped, full ped, or lat file units only | | | | | | |
| | Doors standard See options for doors | | | | | | |
| Built in Pedestals (PED) | 82-PED-2017-BF-BI add ped | 19 | 17 | 18 | \$294 | 30 | |
| | remove ped | | | | -\$176 | -30 | |
| | 82-PED-2036-LF-BI add ped | 19 | 36 | 27 | \$776 | 65 | |
| | 82-PED-2032-5DR-BI add ped | 19 | 33 | 24 | \$958 | 70 | |
| | Space Limitations Apply | | | | | | |
| | See Options for full ped upcharge | | | | | | |

Sizes are nominal.

8200 Series

Our Hand Selected Veneers Set the Veneer Standard for Excellence Expected by the Discerning Customer.

| | Model Number | Depth | Width | Height | List | Weight | Cube |
|--|---|-------|-------|--------|---------------------|--------|------|
| OPTIONS: | | | | | | | |
| Center Drawer Large | Op-WD-CD-Large | 20 | 24 | 3 | \$110 | 4 | 2 |
| Center Drawer Small | Op-WD-CD-Small | 20 | 20 | 3 | \$110 | 4 | 2 |
| Full Pedestal With Lock File File Configuration Or Box Box File Configuration (Includes Full Modesty) | Op-FULL PED | | | | \$246 | 225 | |
| 1/2 Cylinder Base with Full Modesty Panel | Op-Cylinder MOD | | | | \$488 | 40 | |
| Hutch Doors | 21-H-Full Glass Doors | 1 | | 26 | \$856 | 20 | |
| | 21-CH-Full Glass Doors | 1 | | 26 | \$856 | 20 | |
| | 21-H-Upper Half Glass Doors | 1 | | 13 | \$708 | 10 | |
| | 21-CH-Upper Half Glass Doors | 1 | | 13 | \$708 | 10 | |
| Printer and CPU Doors | 21-CPU-Door | 1 | 12 | 24 | \$110 | 3 | |
| | 21-PPO-Door | 1 | 21 | 24 | \$110 | 4 | |
| Overhead Doors | Op-OH-Doors | 1 | | 13 | \$142 | 5 | |
| Full Modesty Panel | Op-FULL MOD | | | | \$78 | 10 | |
| COLORS: | | | | | | | |
| Light Oak | WLO | | | | | | |
| Medium Oak | WMO | | | | | | |
| Natural Oak | WNO | | | | | | |
| Mahogany on Maple | WMA | | | | | | |
| Light Cherry on Maple | WLC | | | | | | |
| Medium Cherry on Maple | WMC | | | | | | |
| Natural Maple | WNM | | | | | | |
| Mahogany on Cherry | WPM-Mahogany on Cherry | | | | 10% | | |
| Light Cherry on Cherry | WPL-Light Cherry on Cherry | | | | 10% | | |
| Medium Cherry on Cherry | WPC-Medium Cherry on Cherry | | | | 10% | | |
| Walnut on Cherry | WWC-Walnut on Cherry | | | | 10% | | |
| High Pressure Tops | Includes choice from most colors by: Formica, Nevamar, Pionite, & Wilsonart | | | | 20% | | |
| Custom Colors | Please call for availability on custom stain matches | | | | 15% (min. \$350) | | |
| | High Gloss | | | | 15% | | |
| Touch-up Crayons (in all colors) | Specify Color | | | | \$16 | | |
| Touch-up Markers (in all colors) | Specify Color | | | | \$22 | | |



Sizes are nominal.

8200 Series

Our Hand Selected Veneers Set the Veneer Standard for Excellence Expected by the Discerning Customer.



| | Model Number | Description | List |
|--|------------------------|--|---------------------------------|
| Grommet | Op-Grom | (Installed) Hardware, Grommet, 60mm Cable, Black | \$62 |
| | Powered Grommet | Op-Pwr-Grom | Retractable Power Grommet black |
| Power Grommets Holds 1 or 2 Data Modules Only. | Op-IL-RJ11-Cat. 3 | In-line data module, RJ 11Cat. 3 black | \$48 |
| | Op-IL-RJ45-Cat. 3 | In-line data module, RJ 45 Cat. 3 black | \$48 |
| | Op-HW-RJ11-Cat. 3 | Hard wire data module, RJ 11 Cat. 3 black | \$48 |
| | Op-HW-RJ45-Cat. 3 | Hard wire data module, RJ 45 Cat. 3 black | \$48 |
| | Op-HW-RJ45-Cat. 5 | Hard wire data module, RJ 45 Cat. 5 black | \$48 |
| | Op-HW-RJ45-Cat. 6 | Hard wire data module, RJ 45 Cat. 6 orange | \$82 |

Grommet Placement Guide

When choosing an optional grommet, please use the drawings below to determine where you would like the grommet placed on the worksurface. For grommet placement in the modesty panels, place an "M" ahead of the number. Grommets through modesty panels are positioned at the highest possible point on the modesty panel. For example: To have the grommet placed in the center of the modesty panel of a return, indicate "M1" on the order line for that item.

Please Note: Grommets cannot go through pedestals on 20" depth units.

Single Pedestal Right

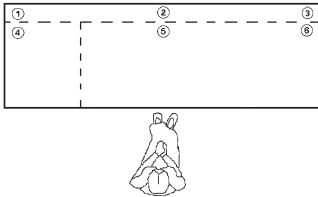

Single Pedestal Left

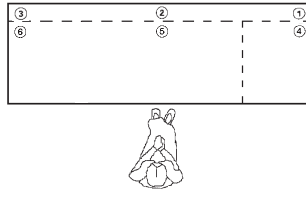

Double Pedestal

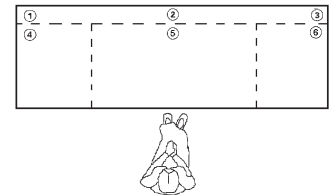

Computer Corner Credenzas

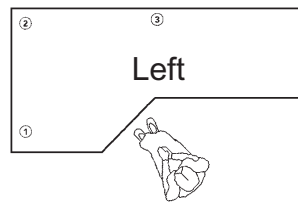
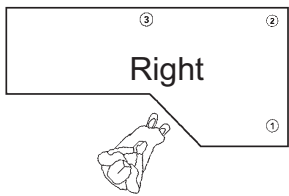

Credenzas

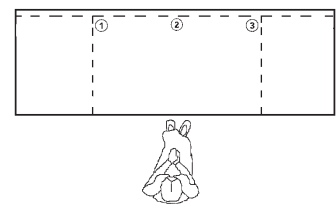

Return Right

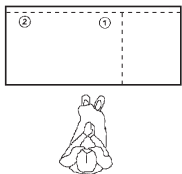

Return Left

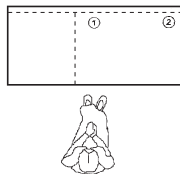

Conference Tables

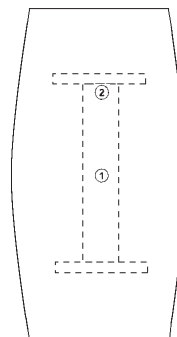

Bullet/P-tops

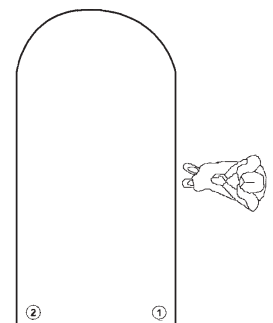

Computer Corner

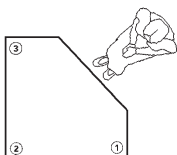

Bridges

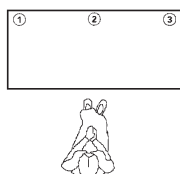

8200 Series

Our Hand Selected Veneers Set the Veneer Standard for Excellence Expected by the Discerning Customer.



Crescent Pull



Wire Pull



Button Pull



Tab Pull



Standard Pull



Traditional Pull



| Model Number | Description | Width | Height | Depth | List |
|--------------|--------------------------|-------|--------|-------|------|
| Op-B1 | Standard Pull Black | 278mm | 18mm | 10mm | \$38 |
| Op-N1 | Standard Pull Nickel | 278mm | 18mm | 10mm | \$38 |
| Op-B2 | Tab Pull Black | 40mm | 26mm | 8mm | \$38 |
| Op-N2 | Tab Pull Nickel | 40mm | 26mm | 8mm | \$38 |
| Op-B3 | Wire Pull Black | 153mm | 30mm | 10mm | \$38 |
| Op-N3 | Wire Pull Nickel | 153mm | 30mm | 10mm | \$38 |
| Op-B4 | Button Pull Black | 31mm | 28mm | 15mm | \$38 |
| Op-N4 | Button Pull Nickel | 31mm | 28mm | 15mm | \$38 |
| Op-B5 | Crescent Pull Black | 100mm | 24mm | 22mm | \$38 |
| Op-N5 | Crescent Pull Nickel | 100mm | 24mm | 22mm | \$38 |
| Op-A6 | Traditional Pull Antique | 147mm | 48mm | 14mm | \$38 |

8200

HARDWARE:

| | | Depth | Width | Height | List | Weight | Cube |
|---|--|-------|-------|--------|-------|--------|------|
| Standard Keyboard Tray | KBT-Standard | 20 | 22 | 2 | \$118 | 10 | 2 |
| Standard Keyboard Tray With Mouse Tray | KBT-Standard-MT | 20 | 22 | 3 | \$196 | 10 | 2 |
| Keyboard Tray With Articulating Arm and Mouse Tray | KBT-ArtArm-MT | 20 | 27 | 4 | \$356 | 10 | 2 |
| Desk Lock | Op-DESK-LOCK | | | | \$62 | | |
| Casters | OP-Casters (add 2" to height) | | | 2 | \$128 | | |
| Cartoning | Corner guards, cardboard top, & sides (Priced per box) | | | | \$74 | | |
| | Bubble Wrap | | | | \$74 | | |
| | Bubble Wrap & Palletize | | | | \$126 | | |

Sizes are nominal.

NOTES

9200 Series

Our Hand Selected Veneers Set the Veneer Standard for Excellence Expected by the Discerning Customer.

Veneer

Standard Features:

- Full Suspension on all Drawers.
- Box/Box/File Pedestals w/handles (Op-B1).
- 1/2" 9 Ply UV Coated Birch Drawer Material
- Touch Latch Doors on Credenzas.
- File Drawers Supplied with Rods for Hanging Legal and Letter Files.
- 20" Depth on Credenzas, Returns, Lateral Files, and Bridges.
- Locks Keyed Alike.
- Matching Vertical Grain Drawer Fronts.
- Solid Hardwood 4 Way Edges on Top
- Available in Five Profiles.
- Vertical Grain Full Modesty Panels.
- Flush Height Returns.
- Adjustable Leveling Glides (except Bookcases).
- Hardwood Molding on Bottom of Side Panels.
- Catalyzed Conversion Varnish Finish.

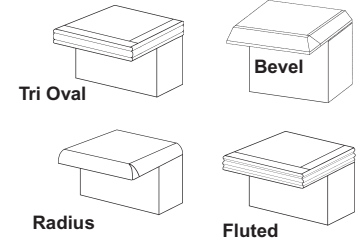

Desks - Double Pedestal/ Single Pedestal/ Fan Desk (DP, FDP, SP)

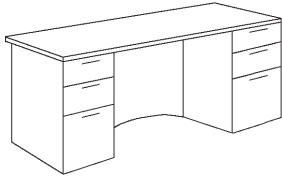

| Model Number | Depth | Width | Height | List | Weight | Cube |
|----------------------|-------|-------|--------|---------|--------|------|
| 92-DP-3060 w/2 locks | 30 | 60 | 29 | \$1,708 | 285 | 36 |
| 92-DP-3066 w/2 locks | 30 | 66 | 29 | \$1,828 | 290 | 40 |
| 92-DP-3672 w/2 locks | 36 | 72 | 29 | \$2,060 | 310 | 51 |
| 92-SP-2448 w/1 lock | 24 | 48 | 29 | \$1,138 | 145 | 24 |

Floating top option available, See options.
 \$264 List to add 6" increments (\$122 List cut downs)

| | | | | | | |
|-----------------------|----|----|----|---------|-----|----|
| 92-FDP-3066 w/2 locks | 36 | 66 | 29 | \$2,368 | 320 | 51 |
| 92-FDP-3672 w/2 locks | 42 | 72 | 29 | \$2,556 | 345 | 59 |

Floating top option available, See options.
 \$350 List to add 6" increments (\$210 List cut downs)

Credenzas (C-Open/C-Cab)

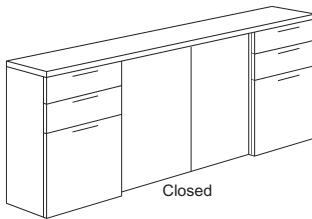

| | | | | | | |
|----------------|----|----|----|---------|-----|----|
| 92-C-2060-Cab | 20 | 60 | 29 | \$1,708 | 233 | 25 |
| 92-C-2060-Open | 20 | 60 | 29 | \$1,708 | 215 | 25 |
| 92-C-2066-Cab | 20 | 66 | 29 | \$1,828 | 239 | 27 |
| 92-C-2066-Open | 20 | 66 | 29 | \$1,828 | 221 | 27 |
| 92-C-2072-Cab | 20 | 72 | 29 | \$2,060 | 245 | 30 |
| 92-C-2072-Open | 20 | 72 | 29 | \$2,060 | 227 | 30 |

Desks with Return (DR)

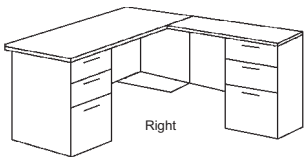

Floating top option available, See options.
 24" Credenza depth add \$264 List
 \$264 List to add 6" increments (\$122 List cut downs)

| | | | | | | |
|------------------------|----|----|----|---------|-----|----|
| 92-DR-3060-2042 | 72 | 60 | 29 | \$2,632 | 305 | 54 |
| • 92-Dsp-3060 w/1 lock | 30 | 60 | 29 | \$1,642 | 210 | 36 |
| • 92-Ret-2042 | 20 | 42 | 29 | \$990 | 95 | 18 |

| | | | | | | |
|------------------------|----|----|----|---------|-----|----|
| 92-DR-3066-2447 | 77 | 66 | 29 | \$2,944 | 350 | 63 |
| • 92-Dsp-3066 w/1 lock | 30 | 66 | 29 | \$1,704 | 225 | 40 |
| • 92-Ret-2447 | 24 | 47 | 29 | \$1,240 | 125 | 23 |

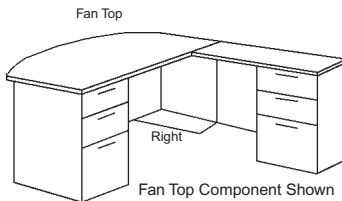

| | | | | | | |
|------------------------|----|----|----|---------|-----|----|
| 92-DR-3672-2047 | 83 | 72 | 29 | \$3,234 | 335 | 69 |
| • 92-Dsp-3672 w/1 lock | 36 | 72 | 29 | \$1,994 | 235 | 51 |
| • 92-Ret-2047 | 20 | 47 | 29 | \$1,240 | 100 | 18 |

| | | | | | | |
|------------------------|----|----|----|---------|-----|----|
| 92-DR-3672-2447 | 83 | 72 | 29 | \$3,234 | 360 | 74 |
| • 92-Dsp-3672 w/1 lock | 36 | 72 | 29 | \$1,994 | 235 | 51 |
| • 92-Ret-2447 | 24 | 47 | 29 | \$1,240 | 125 | 23 |

Fan & P-Top Available (See Components)

Floating top option available, See options.
 \$264 List to add 6" increments (\$122 List cut downs)

Sizes are nominal.

9200 Series

Our Hand Selected Veneers Set the Veneer Standard for Excellence Expected by the Discerning Customer.

Work Tables (WT)

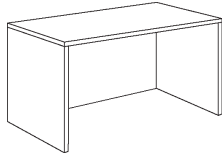

| Model Number | Depth | Width | Height | List | Weight | Cube |
|--------------|-------|-------|--------|---------|--------|------|
| 92-WT-2036 | 20 | 36 | 29 | \$572 | 70 | 15 |
| 92-WT-2042 | 20 | 42 | 29 | \$644 | 90 | 18 |
| 92-WT-2048 | 20 | 48 | 29 | \$736 | 105 | 20 |
| 92-WT-2060 | 20 | 60 | 29 | \$782 | 110 | 25 |
| 92-WT-2072 | 20 | 72 | 29 | \$934 | 125 | 30 |
| 92-WT-2448 | 24 | 48 | 29 | \$652 | 120 | 24 |
| 92-WT-3048 | 30 | 48 | 29 | \$760 | 140 | 29 |
| 92-WT-3060 | 30 | 60 | 29 | \$934 | 150 | 36 |
| 92-WT-3672 | 36 | 72 | 29 | \$1,198 | 170 | 51 |

Floating top option available, See options.
 \$264 List to add 6" increments (\$122 List cut downs)

Lateral Files (LF)

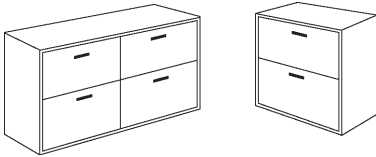

| | | | | | | |
|----------------|----|----|----|---------|-----|----|
| 92-LF-2038-2D | 20 | 38 | 29 | \$1,220 | 185 | 16 |
| 92-LF-2072-4D | 20 | 72 | 29 | \$1,954 | 345 | 30 |
| Locks Standard | | | | | | |

Floating top option available, See options.

For:

- Bookcases
- Conference Tables
- End Tables
- Hutches
- Reception Units
- Storage Cabinets
and
- Other Items

See 8200 Series

Sizes are nominal.

9200 Series

Our Hand Selected Veneers Set the Veneer Standard for Excellence Expected by the Discerning Customer.

Computer U-Shape Desks (CU)

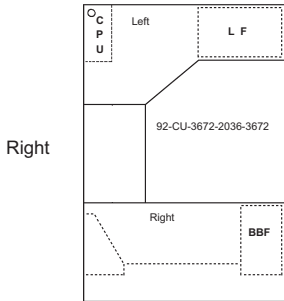

U-Shape Desks (NCU)

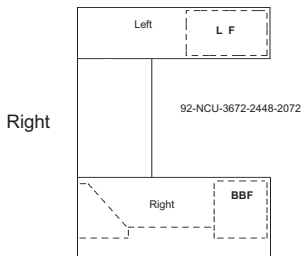

Bullet Computer U-Shape Desks (BCU)

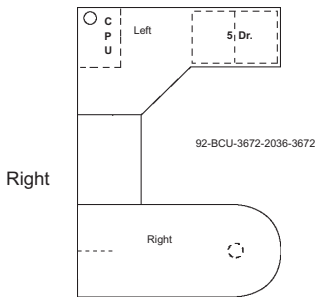

Bullet U-Shape Desks (BNCU)

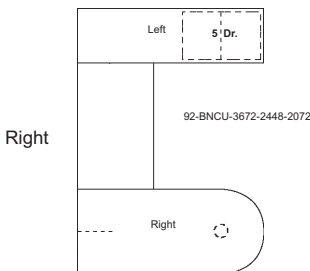

Computer Corner with Return (CR)

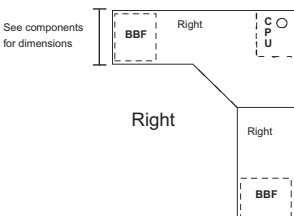

| Model Number | Depth | Width | Height | List | Weight | Cube |
|--|-------|-------|--------|---------|--------|------|
| 92-CU-3066-2036-3666 | 102 | 66 | 29 | \$4,752 | 545 | 102 |
| • 92-Dsp-3066 w/1 lock | 30 | 66 | 29 | \$1,704 | 225 | 40 |
| • 92-BR-2036-BC | 20 | 36 | 29 | \$724 | 105 | 15 |
| • 92-CCCsp-3666-BF | 36 | 66 | 29 | \$2,324 | 215 | 47 |
| 92-CU-3672-2036-3672 | 108 | 72 | 29 | \$5,000 | 605 | 117 |
| • 92-Dsp-3672 w/1 lock | 36 | 72 | 29 | \$1,994 | 235 | 51 |
| • 92-BR-2036-BC | 20 | 36 | 29 | \$724 | 105 | 15 |
| • 92-CCCsp-3672-LF w/1 lock | 36 | 72 | 29 | \$2,282 | 265 | 51 |
| w/handles (B1) | | | | | | |
| Floating top option available, See options. | | | | | | |
| See Components for cut downs | | | | | | |
| 92-NCU-3672-2448-2072 | 103 | 72 | 29 | \$4,442 | 575 | 104 |
| • 92-Dsp-3672 w/1 lock | 36 | 72 | 29 | \$1,994 | 235 | 51 |
| • 92-BR-2447-BC | 24 | 47 | 29 | \$890 | 125 | 23 |
| • 92-Csp-2072-LF w/1 lock | 20 | 72 | 29 | \$1,558 | 215 | 30 |
| w/handles (B1) | | | | | | |
| Fan & P-Top Available (See Components) | | | | | | |
| Floating top option available, See options. | | | | | | |
| See Components for cut downs | | | | | | |
| 92-BCU-3672-2036-3672 | 108 | 72 | 29 | \$5,138 | 520 | 117 |
| • 92-B-3672 | 36 | 72 | 29 | \$2,076 | 150 | 51 |
| • 92-BR-2036-BC | 20 | 36 | 29 | \$724 | 105 | 15 |
| • 92-CCCsp-3672-5DR | 36 | 72 | 29 | \$2,338 | 265 | 51 |
| w/handles (B1) | | | | | | |
| 92-BCU-3684-2036-3672 | 108 | 84 | 29 | \$5,250 | 535 | 125 |
| • 92-B-3684 | 36 | 84 | 29 | \$2,188 | 165 | 59 |
| • 92-BR-2036-BC | 20 | 36 | 29 | \$724 | 105 | 15 |
| • 92-CCCsp-3672-5DR | 36 | 72 | 29 | \$2,338 | 265 | 51 |
| w/handles (B1) | | | | | | |
| Cylinder MOD Optional | | | | | | |
| See Components for cut downs Floating top option available, See options. | | | | | | |
| 92-BNCU-3672-2448-2072 | 103 | 72 | 29 | \$4,526 | 490 | 104 |
| • 92-B-3672 | 36 | 72 | 29 | \$2,076 | 150 | 51 |
| • 92-BR-2447-BC | 24 | 47 | 29 | \$890 | 125 | 23 |
| • 92-Csp-2072-5DR w/handles (B1) | 20 | 72 | 29 | \$1,560 | 215 | 30 |
| Cylinder MOD Optional | | | | | | |
| Fan & P-Top Available (See Components) | | | | | | |
| Floating top option available, See options. | | | | | | |
| See Components for cut downs | | | | | | |
| 92-CR-3666-2042 | 78 | 66 | 29 | \$3,314 | 310 | 65 |
| • 92-CCCsp-3666 | 36 | 66 | 29 | \$2,324 | 215 | 47 |
| • 92-Ret-2042 | 20 | 42 | 29 | \$990 | 95 | 18 |
| 92-CR-3672-2447 | 83 | 72 | 29 | \$3,566 | 350 | 74 |
| • 92-CCDsp-3672 | 36 | 72 | 29 | \$2,326 | 225 | 51 |
| • 92-Ret-2447 | 24 | 47 | 29 | \$1,240 | 125 | 23 |
| Floating top option available, See options. | | | | | | |
| See Components for cut downs | | | | | | |

Sizes are nominal.

9200 Series

Our Hand Selected Veneers Set the Veneer Standard for Excellence Expected by the Discerning Customer.

How to Specify Left or Right Components

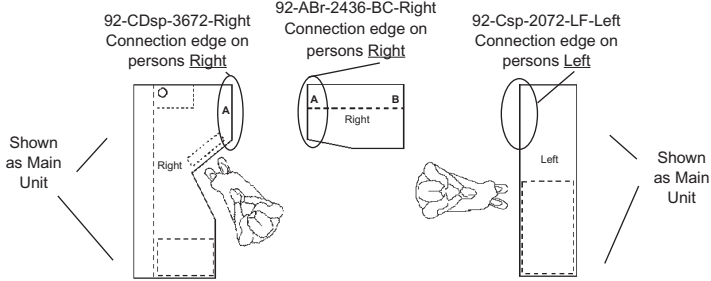

“Right” = Connects to Right side of main desk.

“Left” = Connects to Left side of main desk.

“A” = 20” Width

“B” = 24” Width

Components

Desk Tops

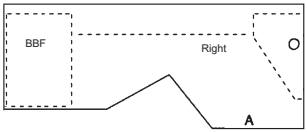
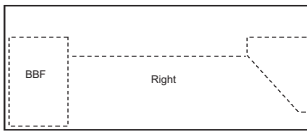

Fan Tops

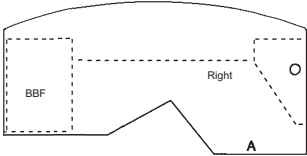
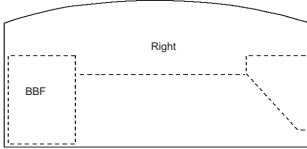

Bullet Tops

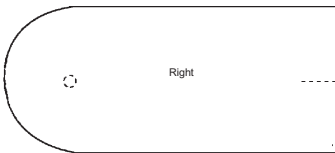

Computer Bullet Tops

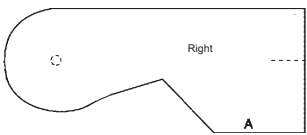

P-Tops

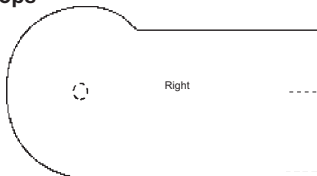

| Model Number | | Depth | Width | Height | List | Weight | Cube |
|--|----------|-------|-------|--------|---------|--------|------|
| 92-Dsp-3060 | w/1 lock | 30 | 60 | 29 | \$1,642 | 210 | 36 |
| 92-Dsp-3066 | w/1 lock | 30 | 66 | 29 | \$1,704 | 225 | 40 |
| 92-Dsp-3672 | w/1 lock | 36 | 72 | 29 | \$1,994 | 235 | 51 |
| Floating top option available, See options. | | | | | | | |
| \$264 List to add 6" increments (\$122 List cut downs) | | | | | | | |
| 92-CDsp-3672 | w/1 lock | 36 | 72 | 29 | \$2,362 | 225 | 51 |
| Floating top option available, See options. | | | | | | | |
| 92-FDsp-3066 | w/1 lock | 36 | 66 | 29 | \$2,254 | 260 | 51 |
| 92-FDsp-3672 | w/1 lock | 42 | 72 | 29 | \$2,490 | 270 | 59 |
| Floating top option available, See options. | | | | | | | |
| \$350 List to add 6" increments (\$210 List cut downs) | | | | | | | |
| 92-FCDsp-3672 | w/1 lock | 42 | 72 | 29 | \$2,766 | 265 | 59 |
| Floating top option available, See options. | | | | | | | |
| 9 2-B-3672 | | 36 | 72 | 29 | \$2,076 | 150 | 51 |
| 92-B-3684 | | 36 | 84 | 29 | \$2,188 | 165 | 59 |
| Cylinder MOD Optional | | | | | | | |
| Floating top option available, See options. | | | | | | | |
| \$350 List to add 6" increments (\$210 List cut downs) | | | | | | | |
| 92-CB-3672 | | 36 | 72 | 29 | \$2,352 | 145 | 51 |
| 92-CB-3684 | | 36 | 84 | 29 | \$2,464 | 155 | 59 |
| Cylinder MOD Optional | | | | | | | |
| Floating top option available, See options. | | | | | | | |
| 92-P-3672 | | 42 | 72 | 29 | \$2,076 | 190 | 59 |
| Cylinder MOD Optional | | | | | | | |
| Floating top option available, See options. | | | | | | | |
| \$350 List to add 6" increments (\$210 List cut downs) | | | | | | | |

Sizes are nominal.

9200 Series

Our Hand Selected Veneers Set the Veneer Standard for Excellence Expected by the Discerning Customer.

Computer P-Tops

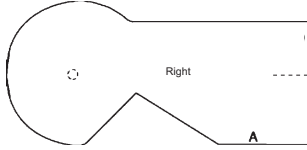

Computer Corners & Credenzas

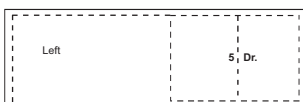
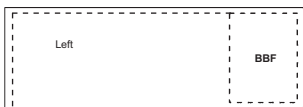
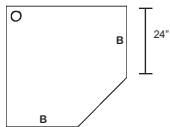
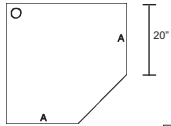
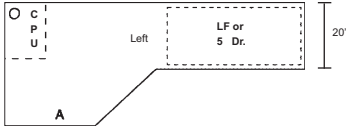
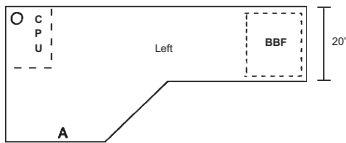
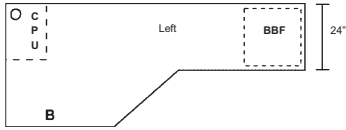



| Model Number | Depth | Width | Height | List | Weight | Cube |
|---|-------|-------|--------|---------|--------|------|
| 92-CP-3672 Cylinder MOD Optional | 48 | 72 | 29 | \$2,562 | 170 | 67 |
| Floating top option available, See options. | | | | | | |
| 92-CCDsp-3672 | 36 | 72 | 29 | \$2,326 | 225 | 51 |
| 92-CCCsp-3666 | 36 | 66 | 29 | \$2,324 | 215 | 47 |
| 92-CCCsp-3672 | 36 | 72 | 29 | \$2,324 | 225 | 51 |
| 92-CCCsp-3672-LF w/1 lock w/handles (B1) | 36 | 72 | 29 | \$2,282 | 265 | 51 |
| 92-CCCsp-3672-5DR w/handles (B1) | 36 | 72 | 29 | \$2,338 | 265 | 51 |
| Floating top option available, See options. \$350 List to add 6" increments (\$210 List cut downs) | | | | | | |
| 21-CC-3636-20 | 36 | 36 | 29 | \$992 | 135 | 26 |
| 21-CC-4242-20 | 42 | 42 | 29 | \$1,144 | 175 | 35 |
| 21-CC-3636-24 | 36 | 36 | 29 | \$992 | 135 | 26 |
| 21-CC-4242-24 | 42 | 42 | 29 | \$1,144 | 175 | 35 |
| Floating top option available, See options. | | | | | | |
| 92-Csp-2060 | 20 | 60 | 29 | \$1,642 | 175 | 25 |
| 92-Csp-2072 | 20 | 72 | 29 | \$1,994 | 195 | 30 |
| 92-Csp-2060-LF w/1 lock w/handles (B1) | 20 | 60 | 29 | \$1,390 | 205 | 25 |
| 92-Csp-2072-LF w/1 lock w/handles (B1) | 20 | 72 | 29 | \$1,558 | 215 | 30 |
| 92-Csp-2072-5DR w/handles (B1) | 20 | 72 | 29 | \$1,560 | 215 | 30 |
| Floating top option available, See options. \$264 List to add 6" increments (\$122 List cut downs) | | | | | | |

Sizes are nominal.

9200 Series

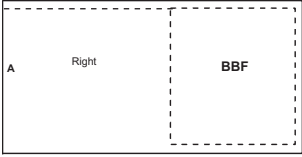
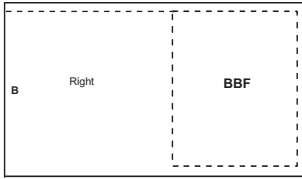
Solid Hardwood Edges, Laminate, Available in Four Profiles, Introduce Artistic Flair to These Stylish Designs.

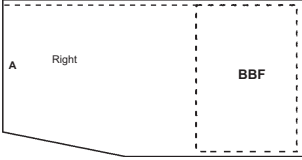
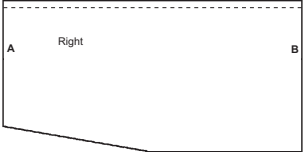
| | Model Number | Depth | Width | Height | List | Weight | Cube |
|--|---|-------|-------|--------|---------|--------|------|
| Returns-20" W/BBF Pedestals  | 92-Ret-2042 | 20 | 42 | 29 | \$990 | 95 | 18 |
| | 92-Ret-2047 | 20 | 47 | 29 | \$1,240 | 100 | 18 |
| | Floating top option available, See options. \$264 List to add 6" increments (\$122 List cut downs) | | | | | | |
| Returns-24" W/BBF Pedestals  | 92-Ret-2436 | 24 | 36 | 29 | \$1,080 | 105 | 18 |
| | 92-Ret-2447 | 24 | 47 | 29 | \$1,240 | 125 | 23 |
| | Floating top option available, See options. \$264 List to add 6" increments (\$122 List cut downs) | | | | | | |
| Rectangular Bridges  | 92-BR-2036 | 20 | 36 | 29 | \$724 | 105 | 15 |
| | 92-BR-2447 | 24 | 47 | 29 | \$890 | 125 | 23 |
| | Floating top option available, See options. \$264 List to add 6" increments (\$122 List cut downs) | | | | | | |
| Angled Returns-24" W/BBF Pedestals  | 92-ARet-2436 | 24 | 36 | 29 | \$1,216 | 100 | 18 |
| | 92-ARet-2447 | 24 | 47 | 29 | \$1,374 | 115 | 23 |
| | Floating top option available, See options. \$264 List to add 6" increments (\$122 List cut downs) | | | | | | |
| Angled Bridge-24"  | 92-ABr-2436 | 24 | 36 | 29 | \$872 | 110 | 18 |
| | 92-ABr-2447 | 24 | 47 | 29 | \$1000 | 120 | 23 |
| | Floating top option available, See options. \$264 List to add 6" increments (\$176 List cut downs) | | | | | | |

Sizes are nominal.

9200 Series

Our Hand Selected Veneers Set the Veneer Standard for Excellence Expected by the Discerning Customer.

| | Model Number | Depth | Width | Height | List | Weight | Cube |
|---|---|-------|-------|--------|---------------------|--------|------|
| OPTIONS: | | | | | | | |
| Center Drawer Large | Op-WD-CD-Large | 20 | 24 | 3 | \$110 | 4 | 2 |
| Center Drawer Small | Op-WD-CD-Small | 20 | 20 | 3 | \$110 | 4 | 2 |
| 1/2 Cylinder Base with Full Modesty Panel | Op-Cylinder MOD | | | | \$488 | 40 | |
| Perforated Metal Modesty Panel | Op-Metal MOD (Nickel) | | | | \$312 | | |
| | Op-Metal MOD (Black) | | | | \$312 | | |
| Floating Top | Op-Float Top (Nickel) (per piece) | | | 2 | \$368 | | |
| | Op-Float Top (Black) (per piece) | | | 2 | \$368 | | |
| Convert Box/Box/File Ped to File/File Ped | Specify File/File | | | | N/C | | |
| | | | | | | | |
| COLORS: | | | | | | | |
| Light Oak | WLO | | | | | | |
| Medium Oak | WMO | | | | | | |
| Natural Oak | WNO | | | | | | |
| Mahogany on Maple | WMA | | | | | | |
| Light Cherry on Maple | WLC | | | | | | |
| Medium Cherry on Maple | WMC | | | | | | |
| Natural Maple | WNM | | | | | | |
| Mahogany on Cherry | WPM-Mahogany on Cherry | | | | 10% | | |
| Light Cherry on Cherry | WPL-Light Cherry on Cherry | | | | 10% | | |
| Medium Cherry on Cherry | WPC-Medium Cherry on Cherry | | | | 10% | | |
| Walnut on Cherry | WWC Walnut on Cherry | | | | 10% | | |
| High Pressure Tops | Includes choice from most colors by: Formica, Nevamar, Pionite, & Wilsonart | | | | 20% | | |
| Custom Colors | Please call for availability on custom stain matches | | | | 15% (min. \$350) | | |
| Touch-up Crayons (in all colors) | Specify Color | | | | \$16 | | |
| Touch-up Markers (in all colors) | Specify Color | | | | \$22 | | |

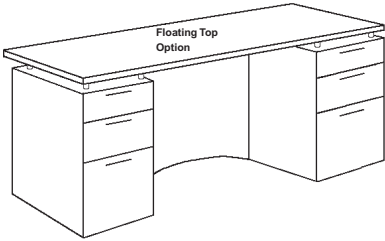

Sizes are nominal.

9200 Series

Our Hand Selected Veneers Set the Veneer Standard for Excellence Expected by the Discerning Customer.



| | Model Number | Description | List |
|----------------|------------------------|--|---------------------------------|
| Grommet | Op-Grom | (Installed) Hardware, Grommet, 60mm Cable, Black | \$62 |
| | Powered Grommet | Op-Pwr-Grom | Retractable Power Grommet black |
| | Op-IL-RJ11-Cat. 3 | In-line data module, RJ 11Cat. 3 black | \$48 |
| | Op-IL-RJ45-Cat. 3 | In-line data module, RJ 45 Cat. 3 black | \$48 |
| | Op-HW-RJ11-Cat. 3 | Hard wire data module, RJ 11 Cat. 3 black | \$48 |
| | Op-HW-RJ45-Cat. 3 | Hard wire data module, RJ 45 Cat. 3 black | \$48 |
| | Op-HW-RJ45-Cat. 5 | Hard wire data module, RJ 45 Cat. 5 black | \$48 |
| | Op-HW-RJ45-Cat. 6 | Hard wire data module, RJ 45 Cat. 6 orange | \$82 |

Power Grommets Holds 1 or 2
Data Modules Only.

Grommet Placement Guide

When choosing an optional grommet, please use the drawings below to determine where you would like the grommet placed on the worksurface. For grommet placement in the modesty panels, place an "M" ahead of the number. Grommets through modesty panels are positioned at the highest possible point on the modesty panel.

For example: To have the grommet placed in the center of the modesty panel of a return, indicate "M1" on the order line for that item.

Please Note: Grommets cannot go through pedestals on 20" depth units.

Single Pedestal Right

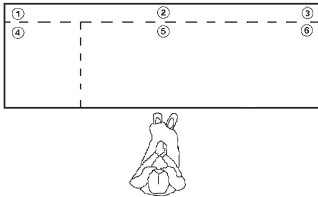

Single Pedestal Left

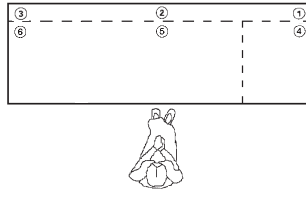

Double Pedestal

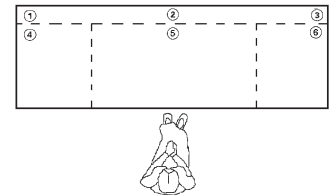

Computer Corner Credenzas

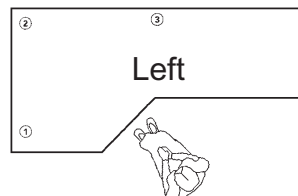
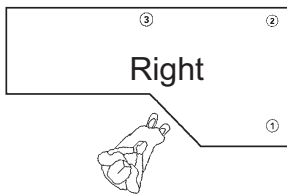

Credenzas

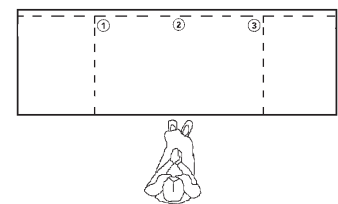

Return Right

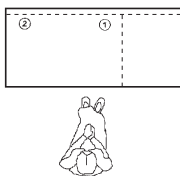

Return Left

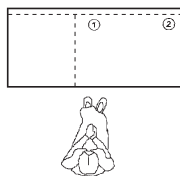

Conference Tables

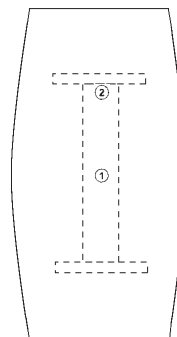

Bullet/P-tops

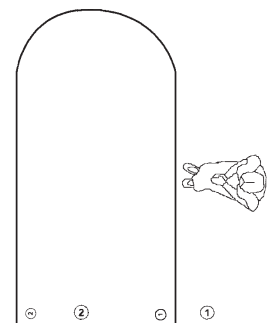

Computer Corner

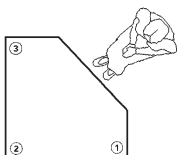

Bridges

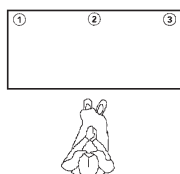

9200

9200 Series

Our Hand Selected Veneers Set the Veneer Standard for Excellence Expected by the Discerning Customer.



Crescent Pull



Wire Pull



Button Pull



Tab Pull



Standard Pull



Traditional Pull



| Model Number | Description | Width | Height | Depth | List |
|--------------|--------------------------|-------|--------|-------|------|
| Op-B1 | Standard Pull Black | 278mm | 18mm | 10mm | \$38 |
| Op-N1 | Standard Pull Nickel | 278mm | 18mm | 10mm | \$38 |
| Op-B2 | Tab Pull Black | 40mm | 26mm | 8mm | \$38 |
| Op-N2 | Tab Pull Nickel | 40mm | 26mm | 8mm | \$38 |
| Op-B3 | Wire Pull Black | 153mm | 30mm | 10mm | \$38 |
| Op-N3 | Wire Pull Nickel | 153mm | 30mm | 10mm | \$38 |
| Op-B4 | Button Pull Black | 31mm | 28mm | 15mm | \$38 |
| Op-N4 | Button Pull Nickel | 31mm | 28mm | 15mm | \$38 |
| Op-B5 | Crescent Pull Black | 100mm | 24mm | 22mm | \$38 |
| Op-N5 | Crescent Pull Nickel | 100mm | 24mm | 22mm | \$38 |
| Op-A6 | Traditional Pull Antique | 147mm | 48mm | 14mm | \$38 |

HARDWARE:

| | Depth | Width | Height | List | Weight | Cube |
|---|-------|-------|--------|-------|--------|------|
| Standard Keyboard Tray | | | | | | |
| KBT-Standard | 20 | 22 | 2 | \$118 | 10 | 2 |
| Standard Keyboard Tray With Mouse Tray | | | | | | |
| KBT-Standard-MT | 20 | 22 | 3 | \$196 | 10 | 2 |
| Keyboard Tray With Articulating Arm and Mouse Tray | | | | | | |
| KBT-ArtArm-MT | 20 | 27 | 4 | \$356 | 10 | 2 |
| Desk Lock | | | | | | |
| Op-DESK-LOCK | | | | \$62 | | |
| Casters | | | | | | |
| OP-Casters (add 2" to height) | | | 2 | \$128 | | |
| Cartoning | | | | | | |
| Corner guards, cardboard top, & sides (Priced per box) | | | | \$74 | | |
| Bubble Wrap | | | | \$74 | | |
| Bubble Wrap & Palletize | | | | \$126 | | |

Sizes are nominal.

Traditional Series

Veneer Traditional Styling, Adds Elegance in the Office.

Veneer

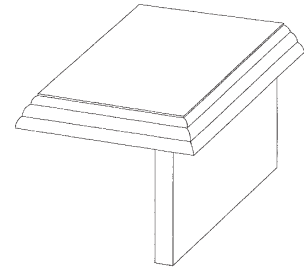

Standard Features:

- Solid Hardwood Traditional Detailing and Molding.
- Dictation Pull-Outs.
- Full Pedestal with Box/Box/File.
- Full Modesty Panels Standard.
- 100% Select Bookmatched Plain Sliced Veneers.
- Center Drawer on Desks.
- 1/2" 9 Ply UV Coated Birch Drawer Material.
- Catalyzed Conversion Varnish Finish.
- Locks Keyed Alike.

Desks - Double/Single Pedestal (DP, SP)

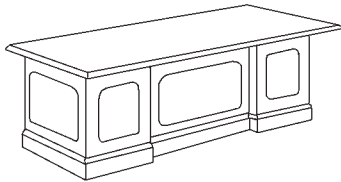

| Model Number | Depth | Width | Height | List | Weight | Cube |
|--|-------|-------|--------|---------|--------|------|
| TD-DP-3066 w/2 locks | 30 | 66 | 29 | \$3,060 | 275 | 40 |
| TD-DP-3672 w/2 locks | 36 | 72 | 29 | \$3,228 | 305 | 51 |
| TD-SP-2450 w/1 lock | 24 | 50 | 29 | \$2,092 | 135 | 24 |
| TD-SP-3066 w/1 lock | 30 | 66 | 29 | \$2,672 | 215 | 40 |
| \$350 List to add 6" increments (\$210 List cut downs) | | | | | | |

Credenzas (C-Open/C-Cab)

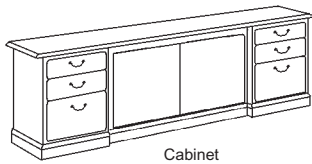

Cabinet

| | | | | | | |
|--|----|----|----|---------|-----|----|
| TD-C-2266-Cab | 22 | 66 | 29 | \$3,060 | 228 | 27 |
| TD-C-2272-Cab | 22 | 72 | 29 | \$3,228 | 235 | 30 |
| TD-C-2266-Open | 22 | 66 | 29 | \$3,060 | 210 | 27 |
| TD-C-2272-Open | 22 | 72 | 29 | \$3,228 | 217 | 30 |
| \$350 List to add 6" increments (\$210 List cut downs) | | | | | | |

Desks with Return (DR)

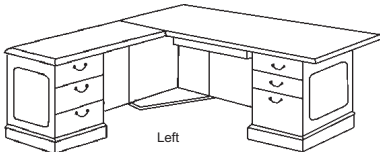

Left

| | | | | | | |
|--|----|----|----|---------|-----|----|
| TD-DR-3066-2448 | 78 | 66 | 29 | \$4,452 | 335 | 63 |
| • TD-Dsp-3066 w/1 lock | 30 | 66 | 29 | \$2,672 | 215 | 40 |
| • TD-Ret-2448 | 24 | 48 | 29 | \$1,780 | 120 | 23 |
| TD-DR-3672-2448 | 84 | 72 | 29 | \$4,730 | 345 | 74 |
| • TD-Dsp-3672 w/1 lock | 36 | 72 | 29 | \$2,950 | 225 | 51 |
| • TD-Ret-2448 | 24 | 48 | 29 | \$1,780 | 120 | 23 |
| TD-DR-3672-2460 | 96 | 72 | 29 | \$5,136 | 360 | 78 |
| • TD-Dsp-3672 w/1 lock | 36 | 72 | 29 | \$2,950 | 225 | 51 |
| • TD-Ret-2460 | 24 | 60 | 29 | \$2,186 | 135 | 27 |
| \$350 List to add 6" increments (\$210 List cut downs) | | | | | | |

Executive U-Shape Workstations (NCU)

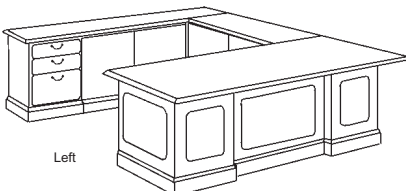

Left

| | | | | | | |
|------------------------------|-----|----|----|---------|-----|-----|
| TD-NCU-3066-2448-2266 | 100 | 66 | 29 | \$6,652 | 545 | 90 |
| • TD-Dsp-3066 w/1 lock | 30 | 66 | 29 | \$2,672 | 215 | 40 |
| • TD-BR-2448 | 24 | 48 | 29 | \$1,308 | 120 | 23 |
| • TD-Csp-2266-Closed | 22 | 66 | 29 | \$2,672 | 210 | 27 |
| TD-NCU-3672-2448-2272 | 106 | 72 | 29 | \$7,208 | 562 | 104 |
| • TD-Dsp-3672 w/1 lock | 36 | 72 | 29 | \$2,950 | 225 | 51 |
| • TD-BR-2448 | 24 | 48 | 29 | \$1,308 | 120 | 23 |
| • TD-Csp-2272-Closed | 22 | 72 | 29 | \$2,950 | 217 | 30 |
| See Components for Cut Downs | | | | | | |

Sizes are nominal.

Traditional Series

Veneer Traditional Styling, Adds Elegance in the Office.

Computer U-Shape Desks (CU)

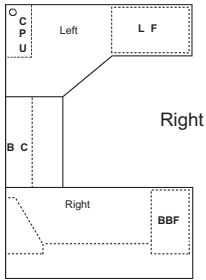

Reception Units (Recep)

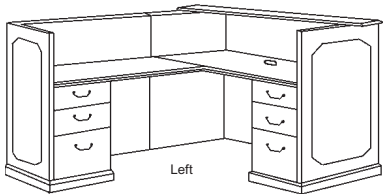

Hutches (H)

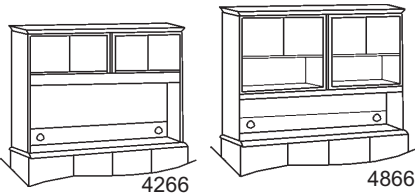

Work Tables (WT)

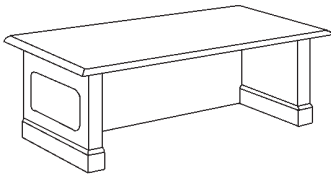

Lateral Files (LF)

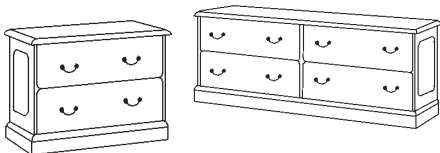

Vertical Files (VF)

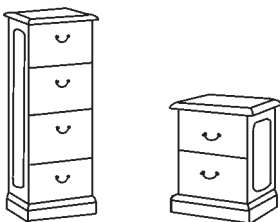

| Model Number | Depth | Width | Height | List | Weight | Cube |
|--|-------|-------|--------|---------|--------|------|
| TD-CU-3066-2236-3666 | 102 | 66 | 29 | \$7,124 | 520 | 102 |
| • TD-Dsp-3066 w/1 lock | 30 | 66 | 29 | \$2,672 | 215 | 40 |
| • TD-BR-2236-BC | 22 | 36 | 29 | \$1,502 | 100 | 15 |
| • TD-CCCsp-3666 | 36 | 66 | 29 | \$2,950 | 205 | 47 |
| TD-CU-3672-2236-3672 | 108 | 72 | 29 | \$7,792 | 575 | 117 |
| • TD-Dsp-3672 w/1 lock | 36 | 72 | 29 | \$2,950 | 225 | 51 |
| • TD-BR-2236-BC | 22 | 36 | 29 | \$1,502 | 100 | 15 |
| • TD-CCCsp-3672-LF w/1 lock | 36 | 72 | 29 | \$3,340 | 250 | 51 |
| See Components for Cut Downs | | | | | | |
| TD-Recep-3066-2448 | 78 | 66 | 43 | \$7,568 | 530 | 91 |
| • TD-Recep-3066 w/1 lock | 30 | 66 | 43 | \$5,342 | 380 | 57 |
| • TD-Recep-Ret-2448 | 25 | 48 | 43 | \$2,226 | 150 | 34 |
| TD-Recep-3072-2448 | 78 | 72 | 43 | \$7,792 | 570 | 108 |
| • TD-Recep-3072 w/1 lock | 30 | 72 | 43 | \$5,566 | 420 | 74 |
| • TD-Recep-Ret-2448 | 25 | 48 | 43 | \$2,226 | 150 | 34 |
| \$526 List to add 6" increments (\$264 List cut downs) | | | | | | |
| TD-H-4866 | 13 | 64 | 48 | \$2,170 | 150 | 32 |
| TD-H-4872 | 13 | 70 | 48 | \$2,260 | 160 | 35 |
| TD-H-4266 | 13 | 64 | 43 | \$1,858 | 130 | 29 |
| TD-H-4272 | 13 | 70 | 43 | \$1,948 | 140 | 31 |
| Wood Doors Standard | | | | | | |
| TD-WT-2236 | 22 | 36 | 29 | \$1,114 | 65 | 15 |
| TD-WT-2448 | 24 | 48 | 29 | \$1,336 | 110 | 24 |
| TD-WT-2266 | 22 | 66 | 29 | \$1,670 | 105 | 27 |
| TD-WT-3066 | 30 | 66 | 29 | \$1,892 | 135 | 40 |
| TD-WT-2272 | 22 | 72 | 29 | \$1,782 | 115 | 30 |
| TD-WT-3672 | 36 | 72 | 29 | \$2,004 | 160 | 51 |
| \$350 List to add 6" increments (\$210 List cut downs) | | | | | | |
| TD-LF-2238-2D | 22 | 38 | 29 | \$1,948 | 170 | 16 |
| TD-LF-2272-4D | 22 | 72 | 29 | \$3,534 | 330 | 30 |
| Locks Standard | | | | | | |
| TD-VF-2422-2D | 24 | 22 | 29 | \$1,642 | 130 | 12 |
| TD-VF-2422-4D | 24 | 22 | 53 | \$2,588 | 280 | 22 |
| Locks Standard | | | | | | |

Sizes are nominal.

Traditional Series

Veneer Traditional Styling, Adds Elegance in the Office.

How to Specify Left or Right Componets

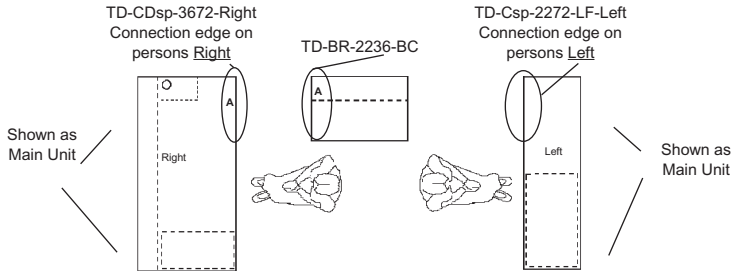

“Right” = Connects to Right side of main desk.

“Left” = Connects to Left side of main desk.

“A” = 22” Width

“B” = 24” Width

Componets

| | Model Number | Depth | Width | Height | List | Weight | Cube |
|---|--|-------|-------|--------|---------|--------|------|
| Desk Tops | TD-Dsp-3066 w/1 lock | 30 | 66 | 29 | \$2,672 | 215 | 40 |
| | TD-Dsp-3672 w/1 lock | 36 | 72 | 29 | \$2,950 | 225 | 51 |
| Computer Corners & Credenzas | \$350 List to add 6" increments (\$210 List cut downs) | | | | | | |
| | TD-CCCsp-3666 | 36 | 66 | 29 | \$2,950 | 205 | 47 |
| | TD-CCCsp-3672-LF w/1 lock | 36 | 72 | 29 | \$3,340 | 250 | 51 |
| | TD-Csp-2266 | 22 | 66 | 29 | \$2,522 | 210 | 27 |
| | TD-Csp-2272 | 22 | 72 | 29 | \$2,800 | 217 | 30 |
| | TD-Csp-2266-Cab | 22 | 66 | 29 | \$2,672 | 230 | 27 |
| | TD-Csp-2272-Cab | 22 | 72 | 29 | \$2,950 | 237 | 30 |
| Returns-24" W/BBF Pedestals | \$350 List to add 6" increments (\$210 List cut downs) | | | | | | |
| | TD-Ret-2448 | 24 | 48 | 29 | \$1,780 | 120 | 23 |
| | TD-Ret-2460 | 24 | 60 | 29 | \$2,186 | 135 | 27 |
| Rectangular Bridges W/Bookcase | \$350 List to add 6" increments (\$210 List cut downs) | | | | | | |
| | TD-BR-2236-BC | 22 | 36 | 29 | \$1,502 | 100 | 15 |
| | TD-BR-2448-BC | 24 | 47 | 29 | \$1,308 | 120 | 23 |
| | \$350 List to add 6" increments (\$210 List cut downs) | | | | | | |

Sizes are nominal.

Traditional Series

Veneer Traditional Styling, Adds Elegance in the Office.

Bookcases (BC)

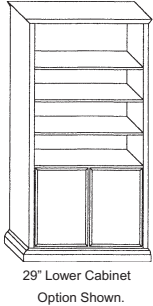

29" Lower Cabinet
Option Shown.

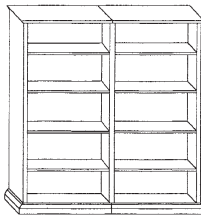

Multiple Bookcase Group
Option Shown.

Racetrack Conference Table (RACE)

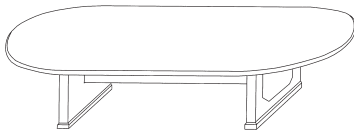

Boat-Shape Conference Table (BOAT)

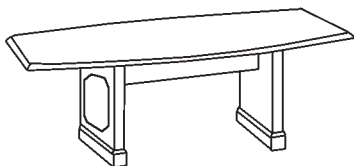

| Model Number | Depth | Width | Height | List | Weight | Cube |
|--|-------|-------|--------|---------|--------|------|
| TD-BC-2936-1 | 29 | 36 | 13 | \$834 | 70 | 10 |
| TD-BC-4834-2L For 2-D Lateral No Bottom | 12 | 34 | 48 | \$1,058 | 75 | 15 |
| TD-BC-4836-2 | 13 | 36 | 48 | \$1,058 | 85 | 16 |
| TD-BC-6036-3 | 13 | 36 | 60 | \$1,224 | 100 | 20 |
| TD-BC-7236-4 | 13 | 36 | 72 | \$1,324 | 115 | 23 |
| TD-BC-8436-5 | 13 | 36 | 84 | \$1,436 | 140 | 27 |
| TD-BC-3612-BKSLF Bookcase Shelf | 12 | 36 | .75 | \$62 | 4 | 1 |
| TD-BC-L-Cab 29" Lower Cabinet (72" & 84" only) | | | | \$334 | 15 | |
| Multiple Bookcase Groups Add Top Profile Reverses on 72" & 84" | | | | 10% | | |
| \$264 List cut downs | | | | | | |
| TD-3672-RACE | 36 | 72 | 29 | \$2,922 | 135 | 22 |
| • TD-3672-RACE-Top | 36 | 72 | 1.2 | \$2,142 | 85 | 6 |
| • TD-3672-REC-BOAT-Base | 25 | 31 | 29 | \$780 | 50 | 16 |
| TD-4896-RACE | 48 | 96 | 29 | \$3,776 | 198 | 37 |
| • TD-4896-RACE-Top | 48 | 96 | 1.2 | \$2,762 | 143 | 10 |
| • TD-4896-REC-BOAT-Base | 25 | 55 | 29 | \$1,014 | 55 | 27 |
| TD-48120-RACE | 48 | 120 | 29 | \$4,990 | 252 | 51 |
| • TD-48120-RACE-Top | 48 | 120 | 1.2 | \$3,654 | 177 | 12 |
| • TD-48120-REC-BOAT-Base | 25 | 81 | 29 | \$1,336 | 75 | 39 |
| TD-48144-RACE | 48 | 144 | 29 | \$6,770 | 312 | 66 |
| • TD-48144-RACE-Top | 48 | 144 | 1.2 | \$4,956 | 212 | 14 |
| • TD-48144-REC-BOAT-Base | 25 | 108 | 29 | \$1,814 | 100 | 52 |
| Top 2-Piece Base 2-Piece | | | | | | |
| \$526 List to add 12" increments (\$210 List cut downs) add 50% for any size up to 60" | | | | | | |
| TD-3672-BOAT | 36 | 72 | 29 | \$2,488 | 135 | 22 |
| • TD-3672-BOAT-Top | 36 | 72 | 1.2 | \$1,708 | 85 | 6 |
| • TD-3672-REC-BOAT-Base | 25 | 31 | 29 | \$780 | 50 | 16 |
| TD-4896-BOAT | 48 | 96 | 29 | \$3,218 | 198 | 37 |
| • TD-4896-BOAT-Top | 48 | 96 | 1.2 | \$2,204 | 143 | 10 |
| • TD-4896-REC-BOAT-Base | 25 | 55 | 29 | \$1,014 | 55 | 27 |
| TD-48120-BOAT | 48 | 120 | 29 | \$4,252 | 252 | 51 |
| • TD-48120-BOAT-Top | 48 | 120 | 1.2 | \$2,916 | 177 | 12 |
| • TD-48120-REC-BOAT-Base | 25 | 81 | 29 | \$1,336 | 75 | 39 |
| TD-48144-BOAT | 48 | 144 | 29 | \$5,776 | 312 | 66 |
| • TD-48144-BOAT-Top | 48 | 144 | 1.2 | \$3,962 | 212 | 14 |
| • TD-48144-REC-BOAT-Base | 25 | 108 | 29 | \$1,814 | 100 | 52 |
| Top 2-Piece Base 2-Piece | | | | | | |
| \$526 List to add 12" increments (\$210 List cut downs) add 50% for any size up to 60" | | | | | | |

Sizes are nominal.

Traditional Series

Veneer Traditional Styling, Adds Elegance in the Office.



| | Model Number | Description | List |
|------------------------|-------------------|--|-------|
| Grommet | Op-Grom | (Installed) Hardware, Grommet, 60mm Cable, Black | \$62 |
| | Op-Pwr-Grom | Retractable Power Grommet black | \$434 |
| Powered Grommet | Op-IL-RJ11-Cat. 3 | In-line data module, RJ 11Cat. 3 black | \$48 |
| | Op-IL-RJ45-Cat. 3 | In-line data module, RJ 45 Cat. 3 black | \$48 |
| | Op-HW-RJ11-Cat. 3 | Hard wire data module, RJ 11 Cat. 3 black | \$48 |
| | Op-HW-RJ45-Cat. 3 | Hard wire data module, RJ 45 Cat. 3 black | \$48 |
| | Op-HW-RJ45-Cat. 5 | Hard wire data module, RJ 45 Cat. 5 black | \$48 |
| | Op-HW-RJ45-Cat. 6 | Hard wire data module, RJ 45 Cat. 6 orange | \$82 |

Power Grommets Holds 1 or 2 Data Modules Only.

Grommet Placement Guide

When choosing an optional grommet, please use the drawings below to determine where you would like the grommet placed on the worksurface. For grommet placement in the modesty panels, place an "M" ahead of the number. Grommets through modesty panels are positioned at the highest possible point on the modesty panel.

For example: To have the grommet placed in the center of the modesty panel of a return, indicate "M1" on the order line for that item.

Please Note: Grommets cannot go through pedestals on 20" depth units.

Single Pedestal Right

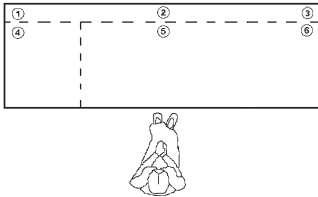

Single Pedestal Left

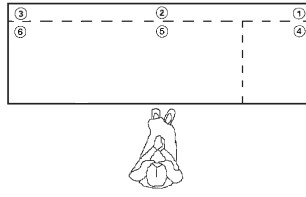

Double Pedestal

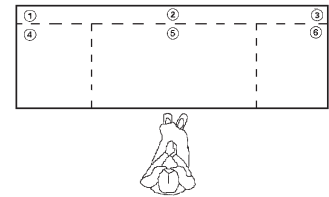

Computer Corner Credenzas

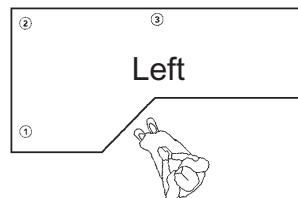
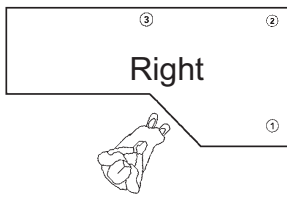

Credenzas

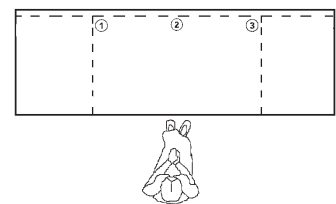

Return Right

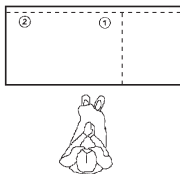

Return Left

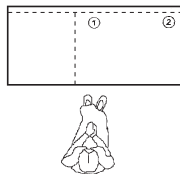

Conference Tables

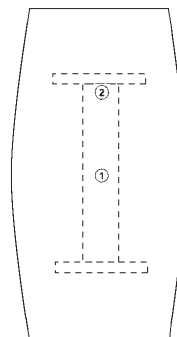

Bullet/P-tops

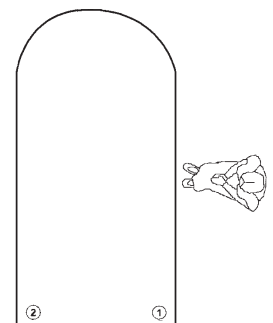

Computer Corner

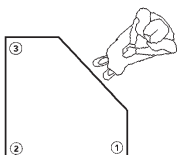

Bridges

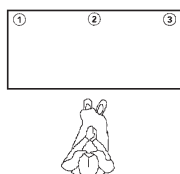

Traditional Series

Veneer Traditional Styling, Adds Elegance in the Office.



Crescent Pull



Wire Pull



Button Pull



Tab Pull



Standard Pull



Traditional Pull



| Model Number | Description | Width | Height | Depth | List |
|--------------|--------------------------|-------|--------|-------|------|
| Op-B1 | Standard Pull Black | 278mm | 18mm | 10mm | \$38 |
| Op-N1 | Standard Pull Nickel | 278mm | 18mm | 10mm | \$38 |
| Op-B2 | Tab Pull Black | 40mm | 26mm | 8mm | \$38 |
| Op-N2 | Tab Pull Nickel | 40mm | 26mm | 8mm | \$38 |
| Op-B3 | Wire Pull Black | 153mm | 30mm | 10mm | \$38 |
| Op-N3 | Wire Pull Nickel | 153mm | 30mm | 10mm | \$38 |
| Op-B4 | Button Pull Black | 31mm | 28mm | 15mm | \$38 |
| Op-N4 | Button Pull Nickel | 31mm | 28mm | 15mm | \$38 |
| Op-B5 | Crescent Pull Black | 100mm | 24mm | 22mm | \$38 |
| Op-N5 | Crescent Pull Nickel | 100mm | 24mm | 22mm | \$38 |
| Op-A6 | Traditional Pull Antique | 147mm | 48mm | 14mm | \$38 |

HARDWARE:

| | Depth | Width | Height | List | Weight | Cube |
|---|-------|-------|--------|-------|--------|------|
| Standard Keyboard Tray | | | | | | |
| KBT-Standard | 20 | 22 | 2 | \$118 | 10 | 2 |
| Standard Keyboard Tray With Mouse Tray | | | | | | |
| KBT-Standard-MT | 20 | 22 | 3 | \$196 | 10 | 2 |
| Keyboard Tray With Articulating Arm and Mouse Tray | | | | | | |
| KBT-ArtArm-MT | 20 | 27 | 4 | \$356 | 10 | 2 |
| Desk Lock | | | | | | |
| Op-DESK-LOCK | | | | \$62 | | |
| Casters | | | | | | |
| OP-Casters (add 2" to height) | | | 2 | \$128 | | |
| Cartoning | | | | | | |
| Corner guards, cardboard top, & sides (Priced per box) | | | | \$74 | | |
| Bubble Wrap | | | | \$74 | | |
| Bubble Wrap & Palletize | | | | \$126 | | |

Sizes are nominal.

NOTES

Individual Uninstalled Hardware

| | Model Number | List |
|--|---|---|
| Brackets | Op-(Qty-1)-Bracket, Corner, .75" x 1" x 1", Black | \$2 |
| | Op-(Qty-1)-Bracket, Corner, 2" x 1" x 1", Black | \$2 |
| | Op-(Qty-1)-Bracket, Angle, .75 Offset, Black | \$2 |
| | Op-(Qty-1)-Bracket, Flat, 16 Guage x .5" x 3", 4 hole pattern | \$2 |
| | Op-(Qty-1)-Bracket, Flat, 11 Guage x 2" x 4", 8 hole pattern black | \$3 |
| Fasteners - Screws | Op-(Qty-10)-Fastener, Screw, PH RD WSH LP CT Z, #8 .5" (Drawer Slide) | \$3 |
| | Op-(Qty-10)-Fastener, Screw, PH PAN CT TY17, #6 1.5" Black (Castle Pocket) | \$3 |
| | Op-(Qty-10)-Fastener, Screw, CT Drywall, #6 1" (Trad) | \$3 |
| | Op-(Qty-10)-Fastener, Screw, PH TR MS Z, #8 x 32 .875" (Handles) | \$3 |
| | Op-(Qty-10)-Fastener, Screw, PF CT T17 NIB, #8 1.5", 117N (Cores/Sides) | \$3 |
| | Op-(Qty-10)-Fastener, Screw, PF CT T17 NIB, #8 1.25", 117N (Conf Tables) | \$3 |
| | Op-(Qty-10)-Fastener, Screw, PH FL TSA, #5 .5", Black, (Striker Plate) | \$3 |
| | Op-(Qty-10)-Fastener, Screw, CT Drywall, #6 .75", (Desk Lock) | \$3 |
| | Op-(Qty-10)-Fastener, Screw, PH MOD TR CT Z, #8 1" (Drawer Front) | \$3 |
| | Op-(Qty-10)-Fastener, Screw, CT Drywall, #8 3", Black, (Hutches) | \$5 |
| | Op-(Qty-10)-Fastener, Screw, PH TR MS Z, #8 x 32 .75", (Handles) | \$3 |
| | Op-(Qty-10)-Fastener, Screw, PH FL CT TSA Z, #6 .625", (Hinges) | \$3 |
| | Op-(Qty-10)-Fastener, Screw, PH TR MS Z, #8 x 32 1.25", (Handles) | \$3 |
| | Op-(Qty-10)-Fastener, Screw Cover, Fast Caps, Black (Stick On) | \$3 |
| | Fasteners - Misc. | Op-(Qty-5)-Fastener, Castle Cap Cover, Black, (Hutches/Bookcases) |
| Op-(Qty-1)-Fastener, Cam, Dowel Assy, 8mm Quickfix | | \$2 |
| Op-(Qty-1)-Fastener, Cam, Klix, 15mm x 12mm, HX Z | | \$2 |
| Op-(Qty-1)-Fastener, Cam, Covers, Black | | \$1 |
| Hardware - Slides | Op-(Qty-1)-Hardware, Drawer Slide, 150lbs, 18", (Lateral File) | \$63 |
| | Op-(Qty-1)-Hardware, Drawer Slide, 100lbs, 18", (Drawer) | \$17 |
| | Op-(Qty-1)-Hardware, Drawer Slide, 100lbs, 18", (Cabinet) | \$35 |
| Hardware - Locks | Op-(Qty-1)-Hardware, Lock, Clip, 3/8", (Desk) | \$2 |
| | Op-(Qty-1)-Hardware, Lock, Clip, 3/8", (Doors) | \$2 |
| | Op-(Qty-1)-Hardware, Lock, Body, Black, (BBF-FF) | \$18 |
| | Op-(Qty-1)-Hardware, Lock, Body, Black, (BF) | \$18 |
| | Op-(Qty-1)-Hardware, Lock, Plug, Black (Specify - Keyed Alike or Keyed Different) | \$10 |
| | Op-(Qty-1)-Hardware, Lock, Body, Black, (Doors) | \$18 |
| | Op-(Qty-1)-Hardware, Lock, Plug Change-Out Key | \$30 |
| Hardware - File Bars | Op-(Qty-1)-Hardware, Pendaflex Bar, .5" x 13.625" | \$5 |
| | Op-(Qty-1)-Hardware, Pendaflex Bar, .5" x 32.375" | \$7 |
| | Op-(Qty-1)-Hardware, Pendaflex Bar, .5" x 17 3/16" | \$5 |
| | Op-(Qty-1)-Hardware, Pendaflex Bar, .625" x 16 9/16" | \$7 |
| Hardware - Kits | Op-(Qty-4)-Hardware, Kit, Pin, Shelf, 5mm x 25mm, BBL | \$4 |
| | Op-(Qty-1)-Hardware, Kit, Drawer, Front/Back File Drawer Conversion | \$18 |
| | Op-(Qty-1)-Hardware, Kit, Drawer, Front/Back Lat File Drawer Conversion | \$26 |
| Hardware - Misc. | Op-(Qty-1)-Hardware, Glide, 1/4 x 20 1", (Levelers) | \$7 |
| | Op-(Qty-10)-Hardware, Felt Bumper, Brown | \$3 |
| | Op-(Qty-1)-Hardware, T-Nut, 1/4 x 20 .875", (Side Panel Feet) | \$2 |

Sizes are nominal.

